

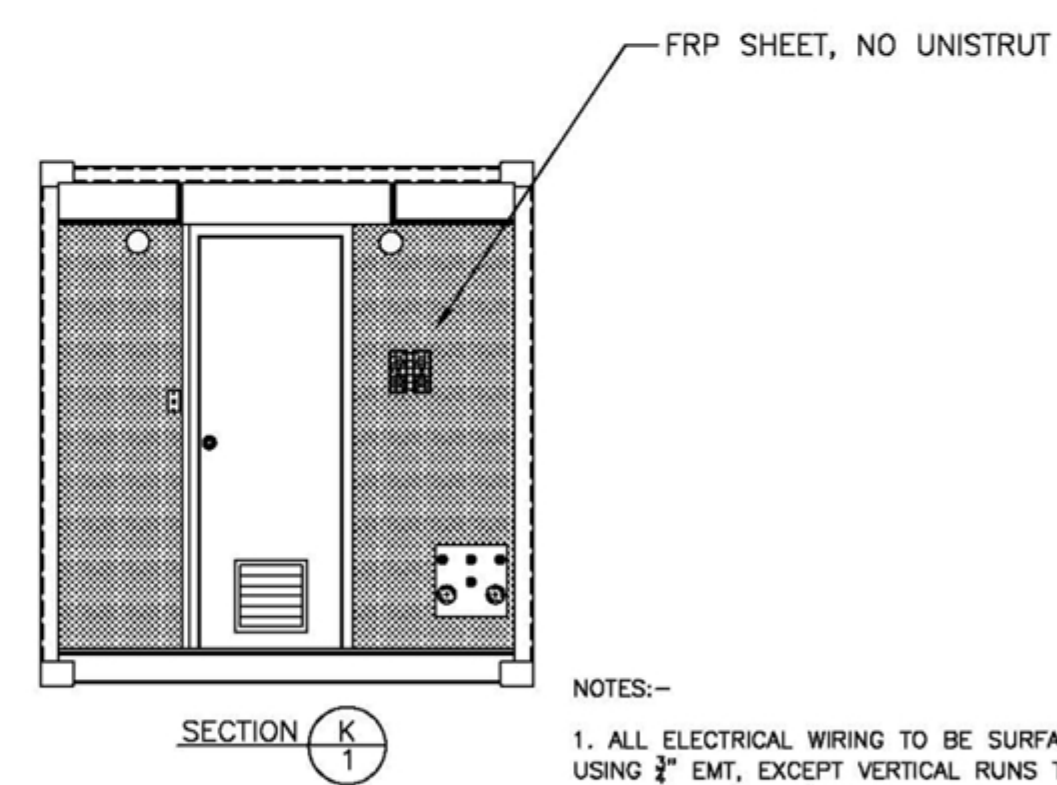

REVISIONS				
ZONE	LTR	DESCRIPTION	DATE	APPROVED
		ISSUED FOR APPROVAL		

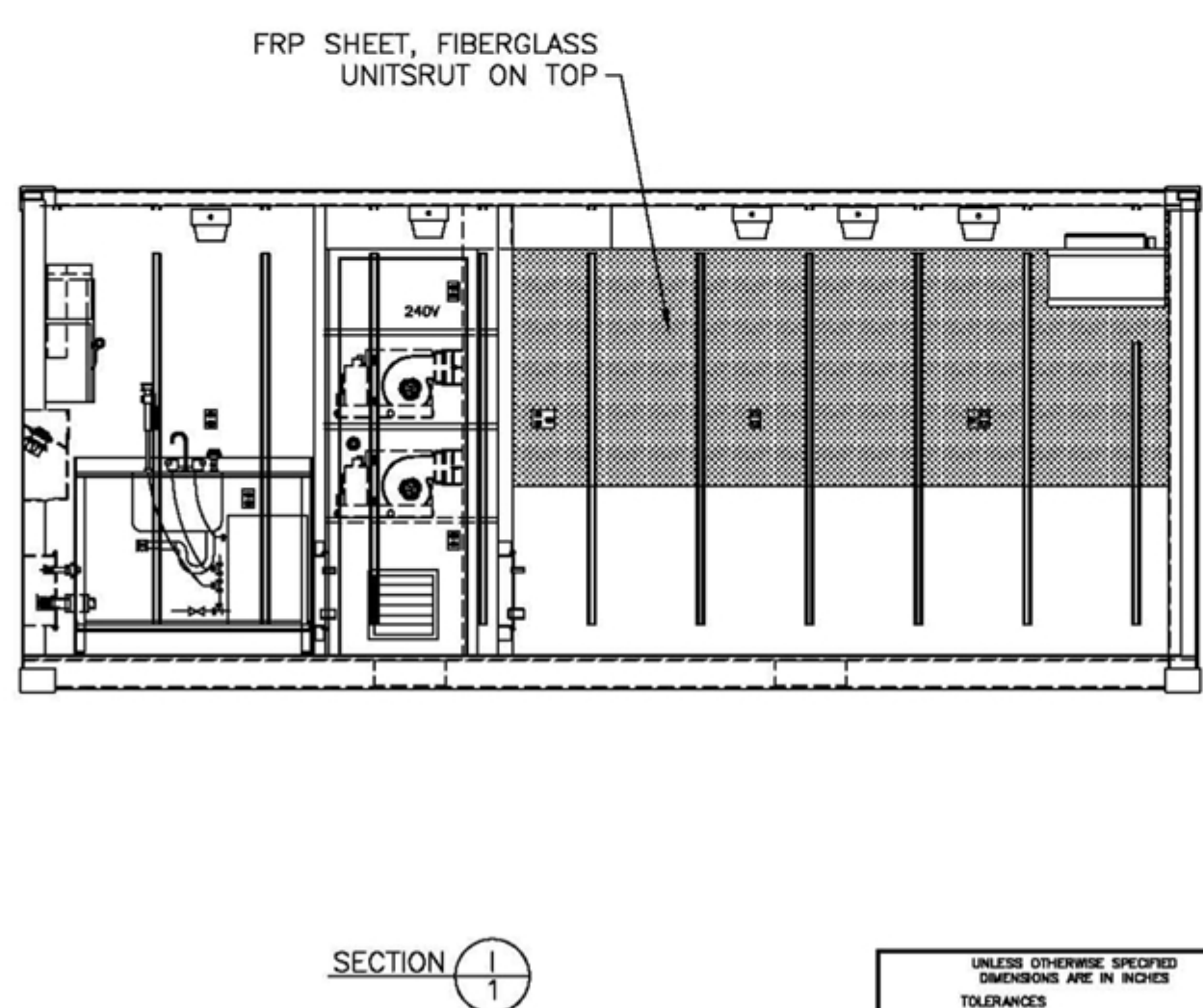
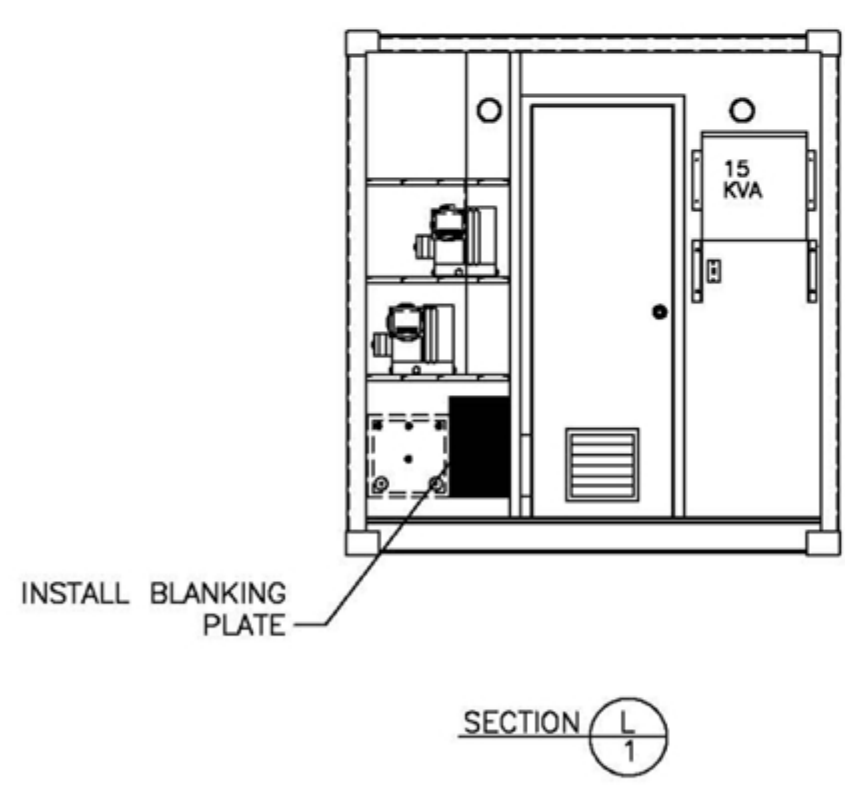
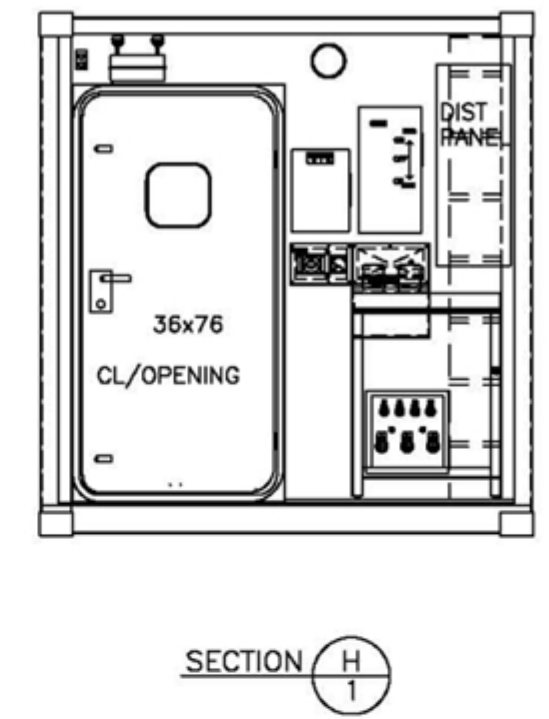
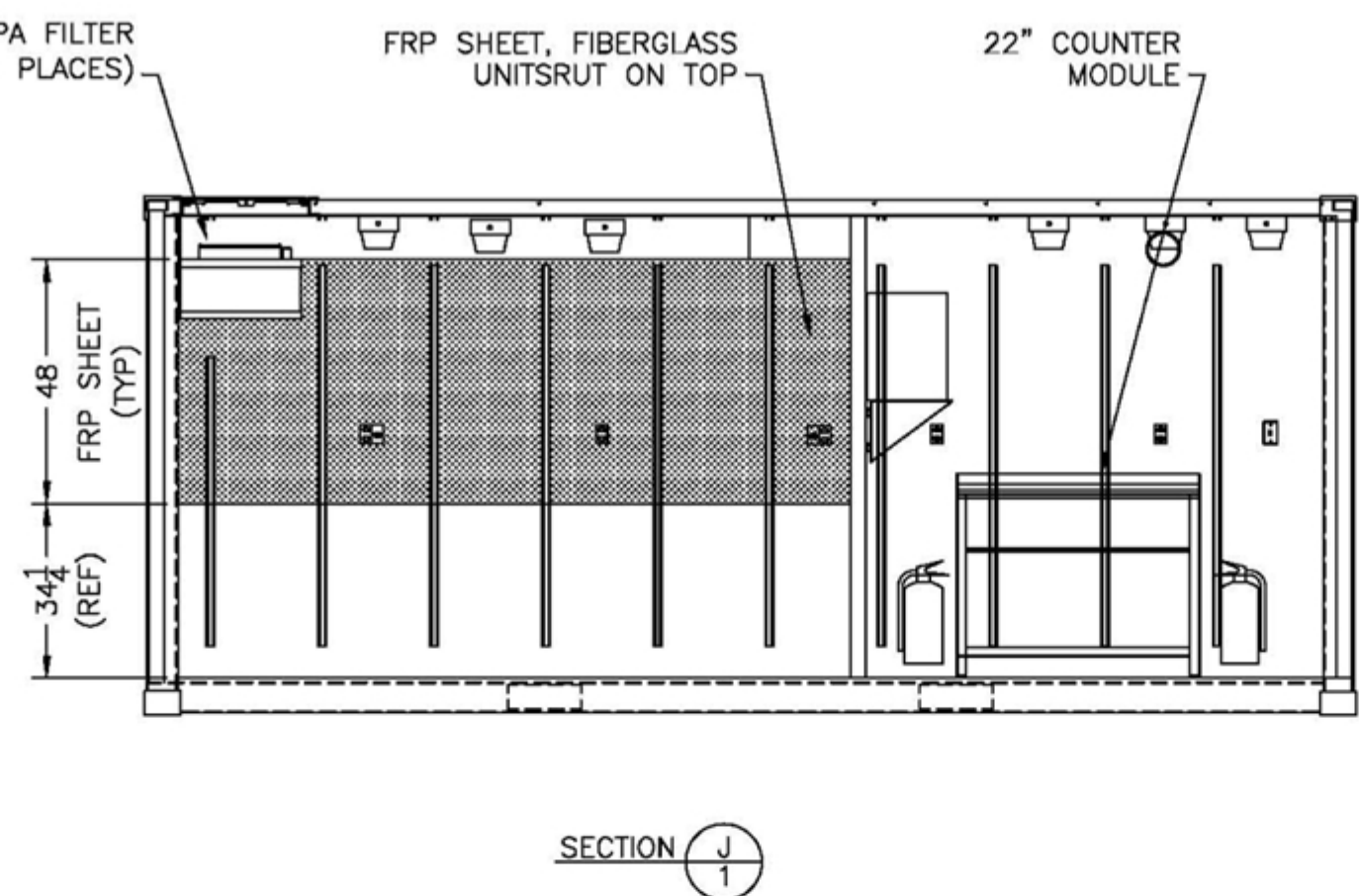
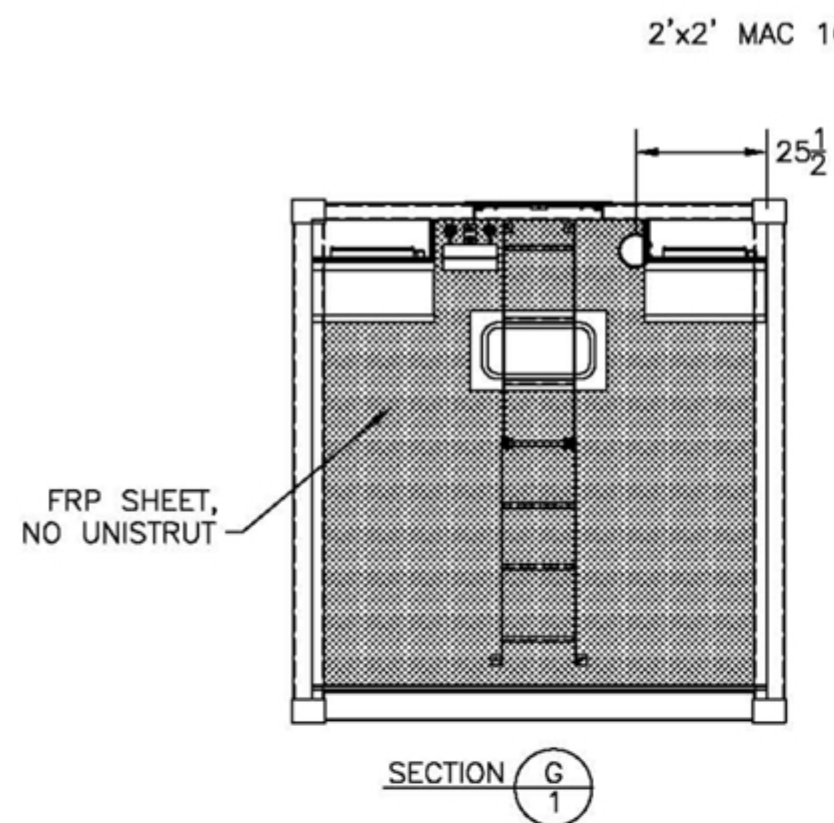

- NOTES:-
1. ALL ELECTRICAL WIRING TO BE SURFACE MOUNTED USING 3/8" EMT, EXCEPT VERTICAL RUNS TO RECEPTACLES WHICH ARE TO BE 1/2" EMT.
 2. MINIMUM WIRE SIZE IS TO BE #12AWG
 3. ALL CABLE/WIRE TO BE STRANDED, T-90
 4. CONDUIT IS TO BE RUN ON THE WALL SURFACE AND NOT ON THE UNISTRUT.

3/16/2005 12:29:41 PM

THIS IS A PROPRIETARY DESIGN OF SONIC ENCLOSURES LTD. MANUFACTURE, REPRODUCTION OR USE OF ANY ASSEMBLY, SUBASSEMBLY OR PART IS PERMISSIBLE ONLY IF EXPRESSLY PRIOR AUTHORIZED IN WRITING BY SONIC ENCLOSURES LTD.

UNLESS OTHERWISE SPECIFIED DIMENSIONS ARE IN INCHES TOLERANCES FRACTIONAL ± 1/16" DECIMAL ± .005" ANGULAR ± 15" DO NOT SCALE DRAWING	CONTRACT No. 625.5.05	DATE 10.MAR.05	 7127 HONEYMAN STREET DELTA B.C. V4G 1E3 PH- 604 946-6100 FX- 604 946-6967	
	DRAWN TCB CHECK	DESIGN	TITLE INTERIOR VIEWS DETAIL TRACE METAL ALUMINUM VAN	
	DESIGN ACTIVITY		SIZE	FSCM NO
	CUSTOMER		DWG No 625505-02	
	UNOLS		SCALE NTS	RELEASE DATE
			SHEET 2 OF 4	