



TABLE OF CONTENTS

Introduction.....	2
Features.....	2
Safety Precautions.....	2
PXV3	
Model Configuration	3
Specifications.....	3
Outer Dimensions and Panel Cutout Size	4
Installation	4
Wiring Instructions:	5
Front Panel Description.....	5
Front Panel Operation	5
PXW	
Model Configuration	6
Specifications.....	6
Outer Dimensions and Panel Cutout Size	8
Installation	8
Wiring Instructions:	9
Front Panel Description.....	10
System Wiring Diagrams.....	10
Front Panel Operation	11
Autotuning.....	11
Programming	
Primary Menu	11
Secondary Menu.....	12
Factory Preset Menu	16
Error Messages	18
Appendix A: Autotuning.....	18
Appendix B: Manual Tuning	19
Appendix C: Heater Break Option.....	21
Appendix D: Heat/Cool Option.....	22
Quick Reference.....	24

Free Technical Support:
1-800-884-4967 U.S. & CANADA
802-863-0085 INT'L
802-863-1193 Fax
 8:30 A.M. - 6:00 P.M. E.S.T.

V298.8

INTRODUCTION

Thank you for purchasing the Fuji Electric temperature/process controller. All of these controllers are PID Autotune controllers that employ Fuji Electric's patented fuzzy logic algorithms.

It is a fully programmable temperature/process controller incorporating many user-friendly features. The following easy-to-use instructions are intended to help you understand, set up, effectively operate, and achieve optimal performance from your controller. When programmed and operated within the guidelines set up for them in this manual, your controller will give you years of precise, reliable control. If needed, we will provide free technical support throughout the life of the controller.

The first section of this manual details the specifications and general description for the PXV3 controller. The second section will cover the PXW controller, followed by a detailed description of the programming parameters, which are common to both the controllers. Several appendices describe some of the controlling techniques. Finally, a Quick Reference guide gives a listing of all the parameters and their default values.



FEATURES

- Fuzzy Logic Control
- PID Autotune with manual override - heating or cooling
- Programmable control action - reverse or direct
- Programmable cycle time
- Programmable inputs - Thermocouple/ RTD, Current/ Voltage
- Sensor burn-out protection
- Input calibration by user
- Outputs: Relay, Solid-state relay drive, or 4-20mA DC (4-20mA not available on PXV3)
- Secondary output for cooling (optional)
- High/low alarm outputs (optional)
- Heater break alarm (optional) (only on PXW 5,7,9)
- Menu driven format
- Setting – touch keys on front panel
- Programmable 8-segment ramp/soak function
- Digital filtering (to suppress factory noise)
- Adjustable setpoint range
- Selectable °F/°C
- Offset adjustments
- Programmable decimal point
- Programmable lock feature
- Advanced security options to prevent unauthorized parameter changes
- 4-digit, LED indication
- Output status indication
- Fault indication
- Non-volatile memory
- 1/32, 1/16, 1/8, 1/4 DIN and 72mm panel mount package
- NEMA 4X faceplate
- ABS plastic housing
- Termination— screw-down type (PXV3, PXW-5, 7, 9) or socket with screw-down terminals (PXW-4)
- Metal mounting bracket; plastic bracket for PXV3/PXW-4
- 85 to 264V AC free voltage power supply
- 24V AC/DC power supply (optional)

- UL, C-UL, and CE approvals
- 3-year warranty

SAFETY PRECAUTIONS

Before using this product, the user is requested to read the following precautions carefully to ensure safety. The safety requirements are classified as either "warning" or "caution" according to the following explanations:

 Warning	suggesting that the user's mishandling can result in personal death or serious injury.
 Caution	suggesting that the user's mishandling can result in personal injury or damage to the property.

 **Warning**

Wiring

1. If there is danger of serious accident resulting from a failure or defect in this unit, provide the unit with an appropriate external protective circuit to prevent an accident.
2. The unit is normally supplied without a power switch or a fuse. Use power switch and fuse as required (Rating of the fuse: 250V, 1A)

Power supply

1. Be sure to use the rated power supply voltage to protect the unit against damage and to prevent failure.
2. Keep the power off until all of the wiring is completed so that electric shock and trouble with the unit can be prevented.

General

1. Never attempt to disassemble, modify, or repair this unit. Tampering with the unit may result in malfunction, electric shock, or fire.
2. Do not use the unit in combustible or explosive gaseous atmospheres.

 **Caution**

Installation

1. Avoid installing the unit in places where:
 - the ambient temperature may reach beyond the range of -10 to 50°C (14 to 122°F) while in operation
 - the ambient humidity may reach higher than 90% RH while in operation
 - a change in the ambient temperature is so rapid as to cause condensation
 - corrosive gases (sulfide and ammonia gas, in particular) or combustible gases are emitted
 - the unit is subject to vibration or shock
 - the unit is likely to come in contact with water, oil, chemicals, steam, or vapor
 - the unit is exposed to dust, salt, or air containing iron particles
 - the unit is subject to interference with static electricity, magnetism, or noise
 - the unit is exposed to direct sunlight
 - heat may be accumulated due to radiation

Maintenance

1. Do not use organic solvents such as alcohol or benzene to wipe this unit. Use a neutral detergent.
2. Three-year warranty is guaranteed only if the unit is properly used.

PXV3 MODEL CONFIGURATION



Type of Input	Code
Thermocouple (°C)	T
Thermocouple (°F)	R
RTD/Pt100 (°C)	N
RTD/Pt100 (°F)	S
4-20mA DC, 1-5V DC	B
0-20mA DC, 0-5V DC	A

Control Output 1	Code
Relay contact (reverse action)	A
Relay contact (direct action)	B
SSR/SSC driver (reverse action)	C
SSR/SSC driver (direct action)	D

Control Output 2	Code
None	Y
Relay contact (reverse action)	A
Relay contact (direct action)	B

Alarm Option	Code
None	4
High/Low alarm (SPST)*	5

*Available with single output only

Power Supply Option	Code
85-264 VAC	-
24V AC/DC	D

PXV3 SPECIFICATIONS

INPUT RANGE TABLE:

Input Signal	Input Range (°C)	Input Range (°F)	Remarks
Thermocouple			
J	0~800	32~1472	Cold Junction compensating function built-in
K	0~1200	32~2192	
R	0~1600	32~2912	
B	0~1800	32~3272	
S	0~1600	32~2912	
T	-199~200	-328~392	
T	-150~400	-238~752	
E	-199~800	-328~1472	
N	0~1300	32~2372	
PL2	0~1300	32~2372	
RTD			
Pt100	-150~850	-238~1562	Allowable wiring resistance 10 ohms max (per wire)
DC Voltage/Current			
1-5V 0-5V 4-20mA 0-20mA	Scaling Range: -1999 to 9999 Engineering Units		For current input, use the 250Ω resistor to obtain 1-5V or 0-5V DC input

CONTROL FUNCTION

(SINGLE OUTPUT)

Control action	PID control with auto-tuning Fuzzy control with auto-tuning
Proportional band (P)	0-999.9%, of full scale (FS), setting in 0.1% steps
Integral time (I)	0-3200 sec, setting in 1 sec steps
Differential time (D)	0-999.9 sec, setting in 0.1 sec steps
P,I,D = 0:	2-position action
I,D = 0:	Proportional action
Proportional cycle	1-150 sec, setting in 1 sec steps, for relay contact output and SSR/SSC drive output only
Hysteresis width	0-50% FS, setting in 1 E.U. (Engineering Unit) steps, 2-position action only
Anti-reset wind up	0-100% FS, setting in 1 E.U. steps, auto-setting with auto-tuning
Input sampling cycle	0.5 sec
Control cycle	0.5 sec

CONTROL FUNCTION

(DUAL OUTPUT) (Heat/Cool Type)

Heating Proportional band	$P \times 1/2$ (P= 0-999.9%)
Cooling Proportional band	Heating proportional band x Cooling proportional band coefficient Cooling proportional band coefficient= 0-100 0: 2-position action
Integral time	0-3200 sec for heating and cooling
Differential time	0-999.9 sec for heating and cooling
P,I,D= 0:	2-position action (without dead band) for heating and cooling
I,D= 0:	Proportional action
Proportional cycle	1-150 sec, for relay contact output and SSR/SSC drive output only
Hysteresis width	2-position action for heating and cooling: 0.5% FS 2-position action for cooling: 0.5% FS
Anti-reset wind-up	0-100% FS, setting in 1 E.U. steps, auto setting with auto-tuning
Overlap/dead band	±50% of heating proportional band
Input sampling cycle	0.5 sec
Control cycle	0.5 sec

OUTPUT

Relay contact output:	SPST 220V AC/30V DC 2A (resistive load) Mechanical life: 10 ⁷ times (under no load) Electrical life: 10 ⁵ times (under the rated load)
SSR driver output:	On-5V DC typ. (5.5V ±1V), 20mA max. Off-0.5V or less
Alarm output/ 2nd control output:	SPST 220V AC/ 30V DC 2A (resistive load)
Alarm:	Configurable from the front panel keys as Absolute, Deviation, Zone, or Combination alarms with or without the hold feature.

SETTING AND INDICATION

Accuracy:	± 0.5% of FS ± 1 digit (± 1°C for thermocouple) R T/C: 0-400°C: ±1%FS ± 1 digit ± 1°C B T/C: 0-500°C: ±5%FS ± 1 digit ± 1°C
Setting method:	3-key operation
Indicator:	4 digit, 7-segment LED (green)

SELF-DIAGNOSIS

Method:	Program error is monitored with a watchdog timer.
---------	---

PROTECTION FROM POWER FAILURE

Memory protection:	Non-volatile memory. Parameter values remain unchanged with disruption of power. Ramp/soak function has to be re-initiated.
--------------------	---

OPERATING AND STORAGE CONDITIONS

Operating temperature:	-10 to 50°C (14 to 122°F)
Operating humidity:	90% RH or less (non-condensing)
Storage temperature:	-20 to 60°C (-4 to 140°F)
Installation category:	II
Pollution degree:	2

GENERAL SPECIFICATIONS

Rated voltage:	85-264V AC or 24V AC/DC
Power consumption:	5VA or less (100V AC) 8VA or less (240V AC)
Insulation resistance:	20MΩ or more (500V DC)
Withstand voltage:	Power source-Earth: 1500V AC, 1 min Power source-input terminal: 1500V AC, 1 min Earth-relay output: 1500V AC, 1 min Earth-Alarm output: 1500V AC, 1 min Between other terminals: 500V AC, 1 min

Input impedance:	Thermocouple: 1MΩ or more Voltage: 450KΩ or more Current: 250Ω (external resistor)
------------------	--

Allowable signal source resistance:	Thermocouple: 100Ω or less Voltage: 1KΩ or less
-------------------------------------	--

Allowable wiring resistance:	RTD: 10Ω or less per wire
------------------------------	---------------------------

Reference junction compensation accuracy:	± 1 °C (at 23°C)
---	------------------

Process variable offset:	±10% FS
--------------------------	---------

Setpoint variable offset:	± 50% FS
---------------------------	----------

Input filter:	0-900.0 sec, setting in 0.1 sec steps (primary lagging filter)
---------------	--

Noise rejection ratio:	Normal mode noise (50/60Hz): 50dB or more Common mode noise (50/60Hz): 140dB or more
------------------------	---

STRUCTURE

Mounting method:	Panel mounting
Enclosure:	Plastic housing
Protection:	NEMA 4X/ IEC IP66 (front panel)
External terminal:	Pluggable terminal w/screw connection
External dimensions:	48 (W) x 24.5 (H) x 99 (D) [mm]
Weight:	Approx. 100 g
Finish color:	Black (front panel)

DELIVERY

Controller, panel mounting bracket, waterproof gasket, 250Ω precision resistor (when necessary), instruction manual.

OUTER DIMENSIONS & PANEL CUTOUT SIZE

Outer Dimensions

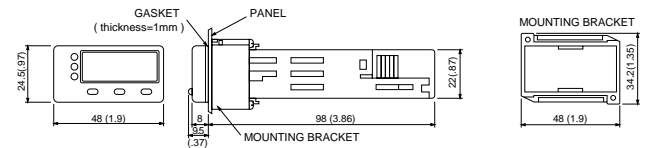

Unit: mm (in.)
Panel thickness: 1 to 8 mm (0.04 to 0.31)

Panel Cutout

When installing “n” number of units (NEMA4X/IP66-compatible)

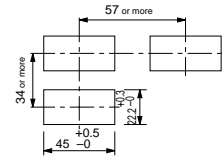

INSTALLATION

NEMA 4X Integrity

The front side of this instrument conforms to NEMA 4X. To ensure the waterproofness between the instrument and the panel, use the gasket that is provided with the unit according to the installation procedure described below.

1. Install the gasket over the enclosure and insert the unit into the panel as shown in Figure 1.
2. Slide the mounting bracket and tighten the screws as shown in Figure 2.

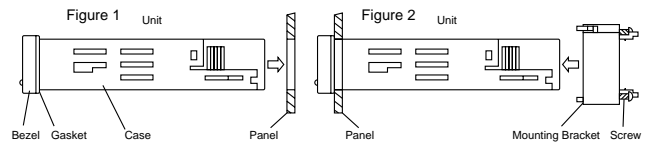

Caution: After the mounting bracket is installed, check the gasket for displacement and detachment as shown in Figure 3.

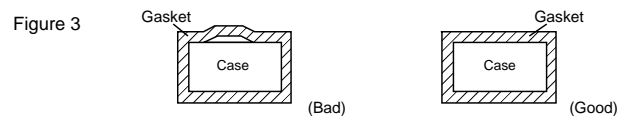

WIRING INSTRUCTIONS

Terminal connection

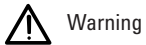

Warning

Be sure to use the rated power supply voltage and polarity.

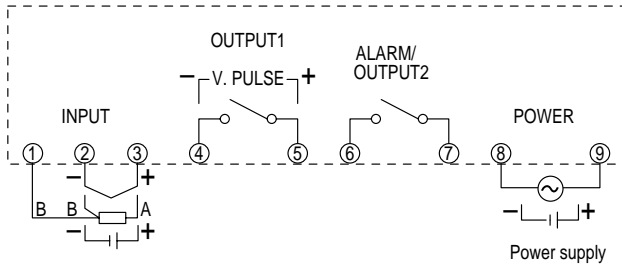

* For current input, install the 250Ω precision resistor (accessory) before using the unit.



Wiring material

1. For terminals 1, 2, 3, use 18 ~ 26 gauge wire.
2. For terminals 4 to 9, use 14 ~ 24 gauge wire.

Please refer to Page 9 for further instructions on wiring power, input and output to the controller.

FRONT PANEL DESCRIPTION

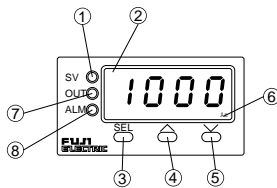

NAME

- ① Set value (SV) indication lamp
- ② Process value (PV)/ Set value (SV)/ parameter display
- ③ Select key
- ④ UP key
- ⑤ DOWN key
- ⑥ Autotuning indication lamp
- ⑦ Control output indication lamp
- ⑧ Alarm indication lamp

FUNCTION

- Comes on when a set value (SV) is displayed
- Process value (PV), Setpoint value (SV), or parameter symbols and codes are displayed.
- To be used when the first, second, or third block parameters are selected
- Pressing the key once will increase the value by one. By pressing it in succession, the value is continuously incremented.
- Pressing the key once will decrease the value by one. By pressing it in succession, the value is continuously decremented.
- Blinks while the PID autotuning is being performed
- Comes on when the control output is ON
- Comes on when the alarm is activated. Blinks while the alarm is being set.

FRONT PANEL OPERATION

The PXV3 controller programming menu consists of three blocks—PRIMARY (SETPOINT) MENU, SECONDARY (SYSTEM) MENU, and FACTORY PRESET MENU. At power up the controller will be in the operational mode, and process variable (PV) will be displayed. This is the variable that is being controlled, and it is not programmable. When setting the parameters, turn off the power to the load (operating equipment) to ensure safety. Since it takes 30 minutes for the unit to stabilize in terms of temperature, all measurements should be carried out at least 30 minutes after the power is turned on. Option-related features are displayed only when the options are provided.

Viewing and Setting Parameters

- The data is automatically registered in 3 seconds after the setting. It can also be registered by pressing the SEL key.

How to set Setpoint value (SV)

Operation

1. Power on.
2. Press SEL key
3. Press UP or DOWN key
4. Press SEL key to go back to the operational mode

Display

- Process value (PV)
- SV value; SV lamp is lit
- SV value changes accordingly
- Process value (PV); SV lamp off

PRIMARY (SETPOINT) MENU

Operation

1. Operational Mode
2. Press SEL key for 3 seconds
3. Press UP or DOWN key
4. Press SEL key to access the next parameter
5. Press SEL key for 3 secs.

Display

- Process value (PV)
- ALM LED blinks; AH data (for units with alarm option)
- AH data changes
- AT 0,
- Operational mode

SECONDARY (SYSTEM) MENU

Operation

1. Operational Mode
2. Press SEL key for 7 seconds
3. Release and press SEL key again
4. Press UP or DOWN key
5. Press SEL key once
6. Press DOWN key to scroll down the menu
7. Press SEL key for 3 secs.

Display

- Process value
- 3 seconds later, ALM LED blinks 7 seconds later, "P"
- "P" data
- "P" data changes accordingly
- "P"
- "i", "d",, "Mod"
- Operational mode

FACTORY PRESET MENU

Operation

1. Operational Mode
2. Press SEL key for 9 seconds
3. Release and press SEL key again
4. Press UP or DOWN key
5. Press SEL key
6. Press DOWN key to scroll down the menu
7. Press SEL key for 3 secs.

Display

- Process value
- 3 seconds later, ALM LED blinks 7 seconds later, "P"
- 9 seconds later, "P-n1"
- "P-n1" data
- "P-n1" data changed
- "P-n1"
- "P-dF",, "dsp7"
- Setpoint value

PXW MODEL CONFIGURATION

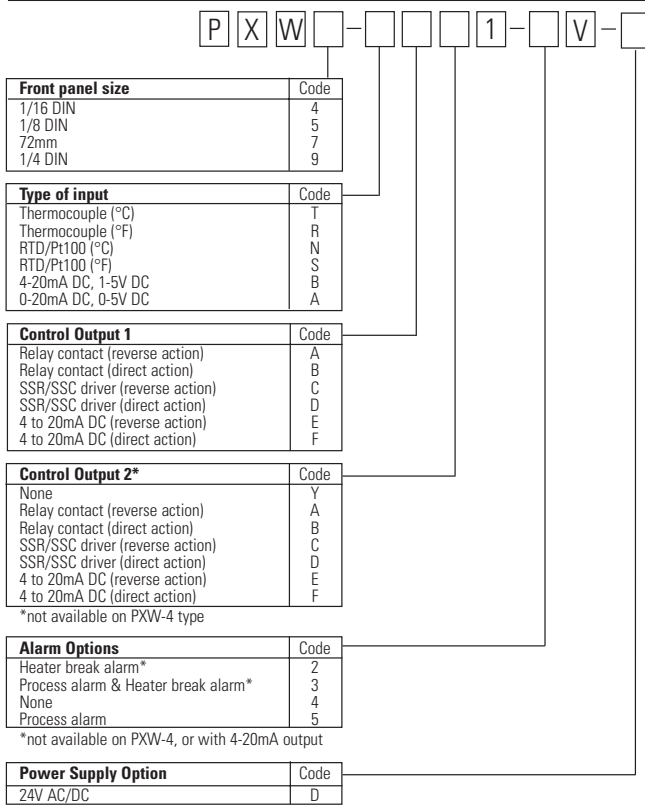

Front panel size	Code
1/16 DIN	4
1/8 DIN	5
72mm	7
1/4 DIN	9

Type of input	Code
Thermocouple (°C)	T
Thermocouple (°F)	R
RTD/Pt100 (°C)	N
RTD/Pt100 (°F)	S
4-20mA DC, 1-5V DC	B
0-20mA DC, 0-5V DC	A

Control Output 1	Code
Relay contact (reverse action)	A
Relay contact (direct action)	B
SSR/SSC driver (reverse action)	C
SSR/SSC driver (direct action)	D
4 to 20mA DC (reverse action)	E
4 to 20mA DC (direct action)	F

Control Output 2*	Code
None	Y
Relay contact (reverse action)	A
Relay contact (direct action)	B
SSR/SSC driver (reverse action)	C
SSR/SSC driver (direct action)	D
4 to 20mA DC (reverse action)	E
4 to 20mA DC (direct action)	F

*not available on PXW-4 type

Alarm Options	Code
Heater break alarm*	2
Process alarm & Heater break alarm*	3
None	4
Process alarm	5

*not available on PXW-4, or with 4-20mA output

Power Supply Option	Code
24V AC/DC	D

ACCESSORIES (Sockets: only for PXW4 and sold separately)

8-pin sockets	(for PXW-4 without H / L Alarm Option)
ATX1NS	Solder Type Socket
PG-08	Screw-down type (terminals on back)
ATX2PSB	Screw-down type (terminals on back) (UL)
TP28X	Screw-down type (terminals on front) (UL)

11-pin sockets	(for PXW-4 with H / L Alarm Option)
PG-11	Screw-down type (terminals on back)
TP311SB	Screw-down type (terminals on back) (UL)
TP311S	Screw-down type (terminals on front) (UL)

Heater Break Current Sensing Transformer:

CTL-6-SF	For heater current (1 to 30 amps)
CTL-12-S36-8F	For heater current (20 to 50 amps)

PXW SPECIFICATIONS

INPUT RANGE TABLE:

Input Signal	Input Range (°C)	Input Range (°F)	Remarks
Thermocouple			
J	0-800	32-1472	Cold Junction compensating function built-in
K	0-1200	32-2192	
R	0-1600	32-2912	
B	0-1800	32-3272	
S	0-1600	32-2912	
T	-199-200	-328-392	
T	-150-400	-238-752	
E	-199-800	-328-1472	
N	0-1300	32-2372	
PL2	0-1300	32-2372	
RTD			
Pt100	-150-850	-238-1562	Allowable wiring resistance 10 ohms max (per wire)
DC Voltage/Current			
1-5V	Scaling Range: -1999 to 9999 Engineering Units		For current input, use the 250Ω resistor to obtain 1-5 V or 0-5V DC input
0-5V			
4-20mA			
0-20mA			

CONTROL FUNCTION

(SINGLE OUTPUT)

Control action	PID control with auto-tuning Fuzzy control with auto-tuning
Proportional band (P)	0-999.9%, of full scale (FS), setting in 0.1% steps
Integral time (I)	0-3200 sec, setting in 1 sec steps
Differential time (D)	0-999.9 sec, setting in 0.1 sec steps
P,I,D = 0:	2-position action
I,D = 0:	Proportional action
Proportional cycle	1-150 sec, setting in 1 sec steps, for relay contact output and SSR/SSC drive output only
Hysteresis width	0-50% FS, setting in 1 E.U. (Engineering Unit) steps, 2-position action only
Anti-reset wind up	0-100% FS, setting in 1 E.U. steps, auto-setting with auto-tuning
Input sampling cycle	0.5 sec
Control cycle	0.5 sec

CONTROL FUNCTION

(DUAL OUTPUT) (Heat/Cool Type)

Heating Proportional band	P x 1/2 (P= 0-999.9%)
Cooling Proportional band	Heating proportional band x Cooling proportional band coefficient Cooling proportional band coefficient= 0-100 0: 2-position action
Integral time	0-3200 sec for heating and cooling
Differential time	0-999.9 sec for heating and cooling
P,I,D= 0:	2-position action (without dead band) for heating and cooling
I,D= 0:	Proportional action
Proportional cycle	1-150 sec, for relay contact output and SSR/SSC drive output only
Hysteresis width	2-position action for heating and cooling: 0.5% FS 2-position action for cooling: 0.5% FS

Anti-reset wind-up	0-100% FS, setting in 1 E.U. steps, auto setting with auto-tuning
Overlap/dead band	±50% of heating proportional band
Input sampling cycle	0.5 sec
Control cycle	0.5 sec

OUTPUT (Single Output)

Control output	One of the following three types is selected: (1) Relay contact (SPDT) 220V AC/30V DC, 3A (resistive load) Mechanical life: 10 ⁷ times (under no load) Electrical life: 10 ⁵ times (under the rated load) (2) SSR/SSC drive (voltage pulse): 15-30V DC at ON/0.5V DC or less at OFF. Current 60mA or less. (3) 4-20mA DC: Allowable load resistance – 600Ω or less.
----------------	--

OUTPUT (Dual Output)

Control output	For dual output type, one of the following three types is selected on both heating and cooling types: (Not available on PXW-4 type) (1) Relay contact (SPDT): 220V AC/30V DC, 3A (resistive load) (2) SSR/SSC drive (voltage pulse): 15-30V DC at ON/0.5V DC or less at OFF. Current: 60mA or less (3) 4-20mA DC: Allowable load resistance – 600Ω or less (Note: When SSR/SSC drive output for heating/cooling side is selected, the total current should be less than 60mA)
----------------	--

SETTING AND INDICATION

Parameter setting method	PXW: digital setting with three keys
PV/SV display method	PV/SV individual LED display, 4 digits each, PV=red, SV=green
Status display	Control output, alarm output, heater break alarm output.
Setting accuracy	0.1% FS
Indication accuracy (at 23°C)	Thermocouple: ± 0.5% FS ± 1 digit ± 1°C R thermocouple: 0-400°C; ± 1% FS ± 1 digit ± 1°C B thermocouple: 0-500°C; ± 5% FS ± 1 digit ± 1°C RTD, voltage, current: ± 0.5% FS ± 1 digit

ALARM

Alarm output	Relay contact (SPST), 220V AC/30V DC, 1A (resistive load) PXW-4 type: 1 point Other types: 2 points
Heater break alarm output	Relay contact (SPST), 220V AC/30V DC, 1A (resistive load) PXW-4 type: not available

GENERAL SPECIFICATIONS

Rated voltage	85-264V AC or 24V AC/DC
Power consumption	10VA or less (100V AC) 15VA or less (240V AC)
Insulation resistance	50MΩ or more (500V DC)
Withstand voltage	Power source-Earth: 1500V AC, 1 min Power source-input terminal: 1500V AC, 1 min Earth-relay output: 1500V AC, 1 min Earth-Alarm output: 1500V AC, 1 min Between other terminals: 500V AC, 1 min
Input impedance	Thermocouple: 1MΩ or more Voltage: 450KΩ or more Current: 250Ω (external resistor)
Allowable signal source resistance	Thermocouple: 100Ω or less Voltage: 1KΩ or less
Allowable wiring resistance	RTD: 10Ω or less per wire
Reference junction compensation accuracy	± 1 °C (at 23°C)
Process variable offset	± 10% FS
Setpoint variable offset	± 50% FS
Input filter	0-900.0 sec, setting in 0.1 sec steps (primary lagging filter)
Noise rejection ratio	Normal mode noise (50/60Hz): 50dB or more Common mode noise (50/60Hz): 140dB or more

POWER FAILURE PROTECTION

Memory protection:	Non-volatile memory. Parameter values remain unchanged with disruption of power. Ramp/soak function has to be re-initiated.
--------------------	---

SELF-CHECK

Method:	Watchdog timer monitors program error.
---------	--

OPERATION AND STORAGE CONDITIONS

Operating temperature	-10 to 50°C (14 to 122°F)
Operating humidity	90% RH or less (non-condensing)
Storage temperature	-20 to 60°C (-4 to 140°F)
Installation category:	II
Pollution degree:	2

OTHER FUNCTIONS

Parameter mask function	Parameter display is disabled by software
Ramp soak function	4-ramp/4-soak

STRUCTURE

Mounting method	Panel flush mounting or surface mounting Surface mounting: PXW-4 type only
External terminal	PXW-4 type: 8-pin or 11-pin socket Other types: screw terminal (M3.5 screw)
Enclosure	Black ABS plastic
Dimensions	PXW-4 48 x 48 x 85.7mm (1/16 DIN) PXW-5 52.5 x 100.5 x 95.8mm (1/8 DIN) PXW-7 76.5 x 76.5 x 95.8mm (72 mm) PXW-9 100.5 x 100.5 x 95.8mm (1/4 DIN)
Weight	PXW-4 approx. 150g PXW-5 approx. 300g PXW-7 approx. 300g PXW-9 approx. 400g
Protective structure	Front panel water-proof structure; NEMA 4X (equivalent to IEC standards IP66) Rear case: IEC IP20

DELIVERY

PXW-4 type: controller, panel mounting bracket, socket (when specified), water proof gasket, 250Ω precision resistor (when required), instruction manual. Other types: controller, panel mounting bracket, water-proof gasket, 250Ω resistor (when required), instruction manual.

OUTER DIMENSIONS & PANEL CUTOUT SIZE

PXW4

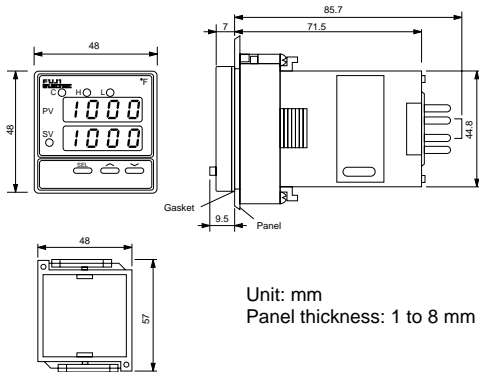

Mounting Bracket

Panel cutout size:
when installing "n" number of units.

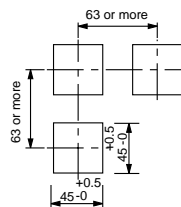

PXW 5,7,9

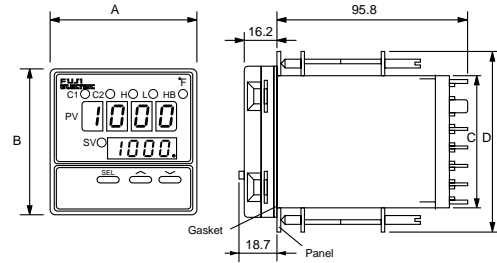

Unit: mm
Panel thickness: 1 to 8 mm

Model	A	B	C	D	E	F	G	H
PXW5	52.5	100.5	90.5	114.5	45 ^{+0.6} ₋₀	92 ^{+0.8} ₋₀	120min	92min
PXW7	76.5	76.5	67	91	68 ^{+0.7} ₋₀	68 ^{+0.7} ₋₀	96min	116min
PXW9	100.5	100.5	90.5	114.5	92 ^{+0.8} ₋₀	92 ^{+0.8} ₋₀	120min	140min

Panel cutout size:
when installing "n" number of units.

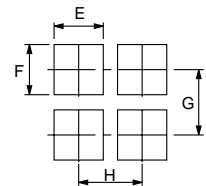

INSTALLATION

NEMA 4X Integrity

The front side of this instrument conforms to NEMA 4X. To ensure the waterproofness between the instrument and the panel, use the gasket that is provided with the unit according to the installation procedure described below.

How to install the unit

For PXW-5/7/9, install the two metal brackets, one on the top and the other on the bottom, and tighten the screws to a torque of about 14.7N-cm (1.5kg-cm). For PXW4, install the unit in the panel as shown below, and tighten the screws on the mounting bracket until the unit is secure. Make sure there is no space between the front side of the unit and the gasket, and between the gasket and the panel.

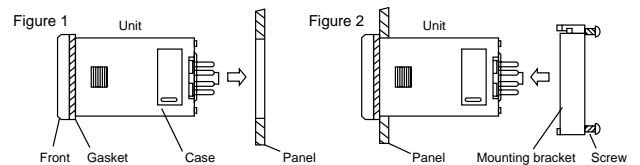

Caution: After the mounting bracket is installed, check the gasket for displacement and detachment as shown in Figure 3.

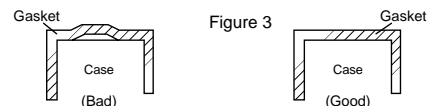

WIRING INSTRUCTIONS

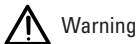

Warning

Be sure to use the rated power supply voltage and polarity.

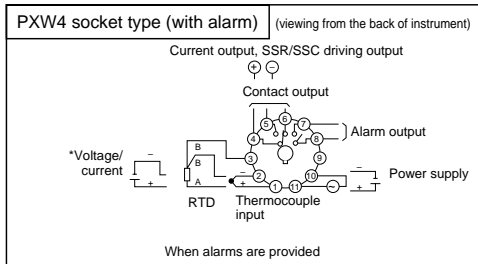
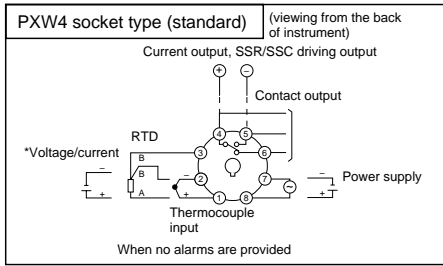

* For current input, install the 250Ω precision resistor (accessory) before using the unit.

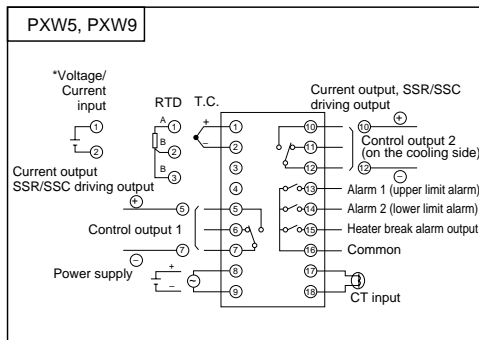
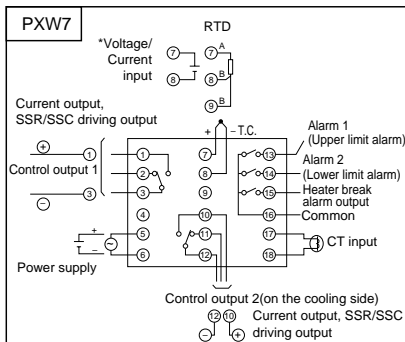

Wiring Power to Controllers

- Be sure to use the rated power supply voltage and polarity for the unit to protect it against damage and to prevent the occurrence of failure.
- Keep the power off until all of the wiring is completed to prevent electric shock and abnormal operation.
- Keep the power supply wires separated from the input and output wires.
- Power connections should be made with 18-gauge or larger insulated wire. Stranded wire improves noise immunity. Noise filters and isolation transformers are recommended in case of noisy power lines.
- When the Heater Break option is selected, use the same power line for both the controller and the heater.

Wiring Inputs

There are two input categories available: Thermocouple/RTD or current/voltage. Make sure you have the right type before wiring the inputs. Refer to Table of Input Type Codes and set the parameter "P-n2" accordingly.

Note: In order to minimize the risk of high frequency noise induced by coils and windings in relays, solenoids, and transformers, use leads which have braided sheath and ground one end of the sheath. Keep your input leads separate from power and output leads. If you have to bring the input signal from a long distance, a signal transmitter might be needed to maintain an accurate reading; in this case, a unit that accepts current/voltage input would be necessary.

Thermocouple

- Connect thermocouples directly to the input terminals whenever possible.
- If using extension wires, make sure they are of the same thermocouple material and grade; any dissimilar metal junctions will lead to erroneous readings.
- Ungrounded thermocouples are recommended for optimal performance and to prevent ground loops.
- Make sure the polarity is correct.

RTD Pt100

- Use a 3-wire Pt100Ω RTD whenever possible. All three wires must have low lead resistance (less than 10Ω) and no resistance differentials among them.
- If using a 2-wire RTD, jumper the two B-legs with a wire of equal resistance.
- Make sure A and B leads are connected to the right terminals.

Current/Voltage

- The controller accepts 1-5V, 0-5V, 4-20mA, and 0-20mA DC signals. If wiring for a voltage input, feed the signal directly to the input terminals. For current inputs, first connect the 250Ω precision resistor that comes with the unit.
- Make sure the polarity is correct.

Wiring Outputs

Before wiring the outputs, make sure the unit has the right kind of control output, and that all the load handling devices conform to the controller specifications. Note that it takes 5 seconds for the outputs to activate after the power is turned on.

Refer to parameter “P-n1” and to the Table of Output Type Codes to choose the preferred type of control action— reverse acting or direct acting.

If using two outputs in a heat/cool type control, please refer to Appendix D for more details.

Relay

- Connecting a load to full capacity of the relay will shorten the relay life, especially if it is operated at a rapid rate. To protect the output relay, an external relay or a contactor should be used. If a higher current rating is required, a solid-state relay driver type output is recommended.
- Connect the load between the normally opened contacts of the relay. This way, if power to the controller is disrupted, the output circuit would open, preventing the load from running out of control.
- Set the proportional time cycle parameter, “TC” to 30 secs. or more.
- Use of “Z-trap” (manufacturer: Fuji Electric Co.) is recommended to protect the relay against switching surges and to ensure the product’s long life. Connect it between the contacts of the relay as shown in the example below.

Part No.: ENC241D-05A (power supply voltage: 100V)
ENC471D-05A (power supply voltage: 200V)

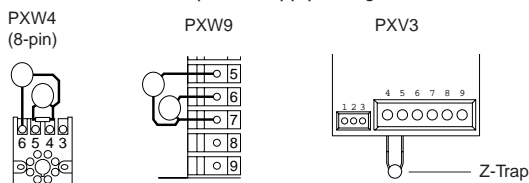

SSR/SSC Driver (Pulsed DC Voltage)

- The non-isolated DC output is used to drive an external load-handling device such as Solid-State Relay(SSR) or Solid-State Contactor(SSC).
- The total current drawn, for both single and dual outputs, should be within the allowed value.
- Make sure the polarity is correct.
- Set the proportional time cycle parameter, “TC” to 1 sec. or more.

4 to 20mA DC

- The output is a non-isolated analog signal used to drive a variety of output devices such as SCRs and valve actuators.
- The load resistance must be less than 600Ω.
- Make sure the polarity is correct.
- The proportional time cycle parameter, “TC” is set to 0, and is not displayed on the programming menu.

Wiring Alarms

- Make sure the load does not exceed the rated capacity of the relay.
- Several types of alarm configurations can be programmed and does not require a change in the wiring. Refer to parameters AL, AH, P-AH, P-AL, P-An.
- For details on Heater Break alarm, please refer to Appendix D and the Heater Break Alarm Setpoint parameter “Hb” in the programming section.

SYSTEM WIRING DIAGRAMS

Example 1:

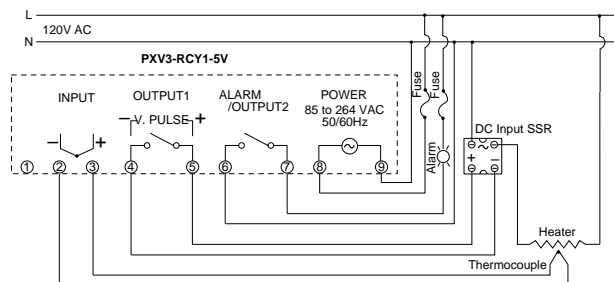

Example 2:

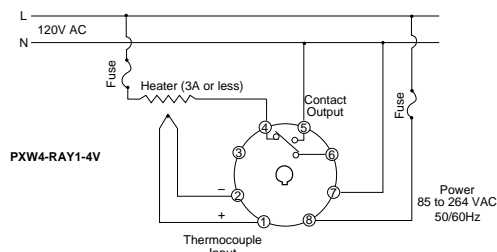

FRONT PANEL DESCRIPTION

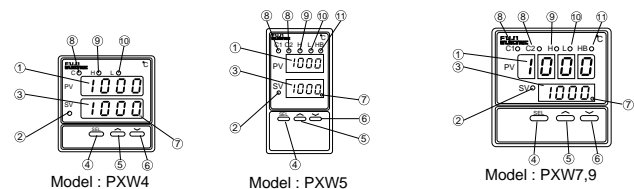

Name	Function
① Process Value (PV) display	Displays the process value (PV).
② Set value (SV) indication lamp	Stays on while a set value is on the display.
③ Set value (SV) and parameter display	Displays set value (SV), or parameter symbol or code when setting various parameters.
④ SELECT key	Key for switching between the parameter blocks and for scrolling within the block.
⑤ UP key	For incrementing the numerical value or scrolling up the the menu. Numerical value changes continuously when held pressed.
⑥ DOWN key	For decrementing the numerical value or scrolling down the menu. Numerical value is decremented continuously when held pressed.
⑦ Auto-tuning indicator	The indicator blinks while the PID auto-tuning is being performed.
⑧ Control Output indication lamp	C: (for PXW4) Stays on while control output is ON. C1: Stays on while control output 1 is ON. C2: Stays on while control output 2 is ON.
⑨ Upper limit alarm indication lamp (optional)	Comes on when the upper limit alarm is activated. Blinks while the alarm value is being set.
⑩ Lower limit alarm indication lamp (optional)	Comes on when the lower limit alarm is activated. Blinks while the alarm value is being set.
⑪ Heater break alarm indication lamp	Comes on when the heater break alarm is output.

FRONT PANEL OPERATION

The PXW controller programming menu consists of three blocks—PRIMARY (SETPOINT) MENU, SECONDARY (SYSTEM) MENU, and FACTORY PRESET MENU. At power up the controller will be in the operational mode, and process variable (PV) and setpoint variable (SV) will be displayed. PV is the variable that is being controlled, and it is not programmable. When setting the parameters, turn off the power to the load (operating equipment) to ensure safety. Since it takes 30 minutes for the unit to stabilize in terms of temperature, all measurements should be carried out at least 30 minutes after the power is turned on. Option-related features are displayed only when the options are used.

Viewing and Setting Parameters

- The data is automatically registered in 3 seconds after the setting. It can also be registered by pressing the SEL key.

How to set Setpoint value (SV)

Operation	Display
1. Power on.	– Operational mode
2. Press UP or DOWN key	– SV value changes accordingly

PRIMARY (SETPOINT) MENU

Operation	Display
1. Operational mode	– PV, SV
2. Press SEL key for 3 seconds	– ‘H’ LED blinks; AH data (for units with alarm option)
3. Press UP or DOWN key	– AH data changes
4. Press SEL key to access the next parameter	– ‘L’ LED blinks, ...
5. Press SEL key for 3 secs.	– Operational mode

SECONDARY (SYSTEM) MENU

Operation	Display
1. Operational mode	– PV, SV
2. Press SEL key for 7 seconds	– 3 seconds later, “H” LED blinks 7 seconds later, “P”
3. Release and press SEL key again	– “P” data
4. Press UP or DOWN key	– “P” data changes accordingly
5. Press SEL key once	– “P”
6. Press DOWN key to scroll down the menu	– “i”, “d”, “Mod”
7. Press SEL key for 3 secs.	– Operational mode

FACTORY PRESET MENU

Operation	Display
1. Operational mode	– PV, SV
2. Press SEL key for 9 seconds	– 3 seconds later, “H” LED blinks 7 seconds later, “P” 9 seconds later, “P-n1”
3. Release and press SEL key again	– “P-n1” data
4. Press UP or DOWN key	– “P-n1” data changed
5. Press SEL key once	– “P-n1”
6. Press DOWN key to scroll down the menu	– “P-df”, “dsp7”
7. Press SEL key for 3 secs.	– Operational mode

AUTOTUNING

Before initiating the autotune function, first decide if you would like to autotune at setpoint or 10% of full scale below setpoint. Set the setpoint (SV), alarms (AL, AH) and the cycle time (TC). Bring your process near setpoint before starting the autotune procedure.

Set the parameter AT to either “1” (to auto-tune at setpoint) or “2” (to auto-tune at 10% of full scale below setpoint) and press SEL key to start auto-tuning. The point indicator at lower right will then start blinking. When the auto-tuning is completed, the point indicator stops blinking and the parameter AT will automatically be set to “0.”

Duration of the autotune process varies with every application. The auto-tuning process may take between 1 and 30 minutes to complete. If it fails to complete, an abnormality may be suspected. In this case, recheck the wiring, control action, and input type code. Refer to page 12 and Appendix A for additional details.

The PID parameters calculated by autotuning will be retained even if the power is lost. However, if the power is turned off during the auto-tuning process, you must restart Autotuning. To abort the autotune procedure, set AT to “0.” Auto-tuning has to be repeated if there is a significant change in SV, P-SL or P-SU, or in the controlled process. Autotuning can also be performed while fuzzy control is selected.

PRIMARY (SETPOINT) MENU

PARAMETER DESCRIPTION

roFF - rhLd		Ramp/Soak Command: The Ramp/Soak program automatically changes the setpoint value with time according to a preset pattern. Setting: roFF : Normal operation is performed rrUn : Ramp/Soak operation is performed rhLd : Ramp/Soak operation is suspended rEnd indicates that the operation is terminated.
Blinking ‘H’ LED	AH	High Alarm Setpoint: The High Alarm Setpoint is that point of the process above which, the high alarm output relay is energized. If the alarm type, programmed in the secondary menu, includes an absolute value for the High Alarm Setpoint, enter the actual value you want the alarm to be activated at regardless of what the main setpoint is set for. If the alarm type includes a deviation value for the High Alarm Setpoint, enter the number of units above main setpoint in which you want the alarm to be activated at; the deviation alarm tracks main setpoint. Settable within the Input Range. Not indicated without the alarm option.
Blinking ‘L’ LED	AL	Low Alarm Setpoint: The Low Alarm Setpoint is that point of the process below which, the low alarm output relay is energized. Absolute and deviation alarm configurations are programmable from within the secondary menu. Settable within the Input Range. Not indicated without the alarm option, or in PXV3.

Blinking 'HB' LED

Hb Heater Break Alarm Setpoint: If the heater's operating current falls below this setpoint, the heater break alarm output relay is energized. This option is used in cases where the PXW is controlling a bank of heaters wired in parallel. A current transformer around the hot lead going to the heater bank and connected to the controller is tied with the controller's output and senses the current used by the heater bank. If one or more of the zones burnout, resulting in cold spots, the current used by the defective heater bank is reduced. By determining what the optimal current and the optimal current minus one zone for the heater bank is, the Heater Break Alarm setpoint can be calculated and entered.
 Setting Range: 0.0 to 50.0 amps.
 Not indicated without the Heater Break Alarm option. Not available on PXW4, or with 4-20 mA DC outputs. Detection is made only on a single-phase heater. This function cannot be used when controlling a heater with SCR phase-angle control. Cycle Time, "TC," must be set at 6 secs. or higher.

$$\begin{array}{r} \text{Optimal Current of} \\ \text{Heater Bank} \\ \text{minus} \\ \text{Optimal Current of} \\ \text{Heater Bank} \\ \text{less One Zone} \end{array} + \begin{array}{r} \text{Optimal Current of} \\ \text{Heater Bank} \\ \text{less One Zone} \end{array} = \begin{array}{r} \text{Heater} \\ \text{Break} \\ \text{Alarm} \\ \text{Setpoint} \end{array}$$

2

Hb

AT Autotuning: Autotuning is the automatic calculation and entering of the control parameters (P, I and D) into memory. Autotuning will also automatically set anti-reset wind-up (Ar). There are two types of Autotuning that can be performed by the controller, Autotuning at main setpoint or Autotuning at 10% of full scale below main setpoint. The latter may yield slightly different values, not as precise, but the process overshoot encountered during the autotuning procedure would not be as much. Enter the value for the type of autotuning you would like to run on your particular application based on overshoot tolerances and the precision of the PID parameters needed. For more information on principles of Autotuning, refer to Appendix A.
 0 - Autotuning off
 1 - Autotuning performed at setpoint
 2 - Autotuning performed at 10% of F.S. below setpoint

Standard type (AT=1)

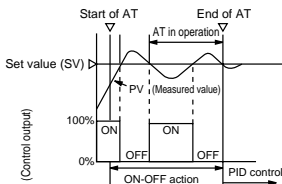

Low PV type (AT=2)

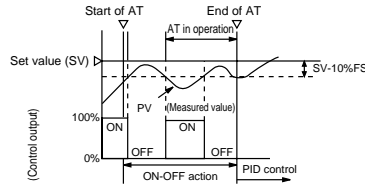

LoC

LoC Lock-out: This function enables or disables changing the settings of parameters.
 Code:
 0 - All parameter settings are changeable
 1 - All parameter settings are locked; cannot be changed
 2 - Only the main setpoint can be changed; all other parameter settings are locked and cannot be changed.

SECONDARY (SYSTEM) MENU

- P Proportional Band:** The proportional band is that area around main setpoint where the control output is neither fully on nor fully off.
 Setting range: 0.0 to 999.9% of full scale
 For On/Off control, set to "0"
- I Integral Time (reset):** The Integral Time is the speed at which a corrective increase or decrease in output is made to compensate for offset which usually accompanies proportional only processes. The more Integral Time entered, the slower the action. The less Integral Time entered, the faster the action. Enter a value that would eliminate offset without overcompensating, leading to process oscillation.
 Setting Range: 0 to 3200 secs
- D Derivative Time (Rate):** The Derivative Time is that time used in calculating rate of change and thermal lag in helping eliminate overshoot which results in response to process upsets. This overshoot usually accompanies proportional only and proportional-integral processes. The derivative action dampens proportional and integral action as it anticipates where the process should be. The more Derivative Time entered, the more damping action. The less Derivative Time entered, the less damping action. Enter as much Derivative Time as necessary to eliminate overshoot without over-damping the process resulting in process oscillation.
 Setting Range: 0.0 to 999.9 secs

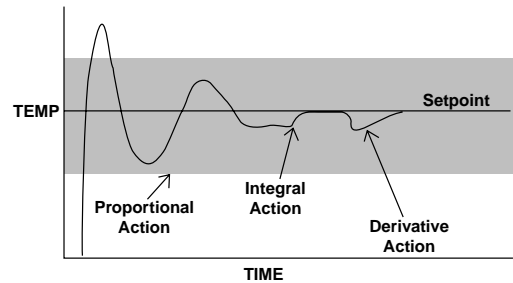

TC Cycle Time (Output #1): The Cycle Time for output #1 is that time where the output is on for a percentage of that time and off for a percentage of that time, creating a proportioning effect. The Cycle Time is only used when P, PI, PD, or PID control action is used, and when the output is time proportional as with the relay or SSR driver outputs. The shorter the Cycle Time, the higher the proportioning resolution is, and better is the control, but there will be an increased strain on the output device. Enter a value that is based on the limitations of your controller's output type.
 Setting range: 1 to 150 secs.
 For relay output: Set to 30 secs. or more.
 For SSR/SSC driver output: Set to 1 sec or more.
 For current output: Set to 0 (normally not indicated)



HYS HYS Hysteresis: Hysteresis is that area around the main setpoint where the output does not change condition. That area or deadband is intended to eliminate relay chatter at setpoint for On/Off control applications. The wider the Hysteresis, the longer it takes for the controller to change output condition. The narrower the Hysteresis, the less time the controller takes to change output condition. When the Hysteresis is narrow, the On/Off control is more accurate but the wear on the output relay is increased. Enter a value which is small enough to meet the control tolerance of the application but large enough to eliminate relay chatter. Setting range: 0 to 50% of FS, set in E.U. for output #1. Hysteresis for On/Off action for dual outputs (heating and cooling) is fixed at 0.5% of FS.

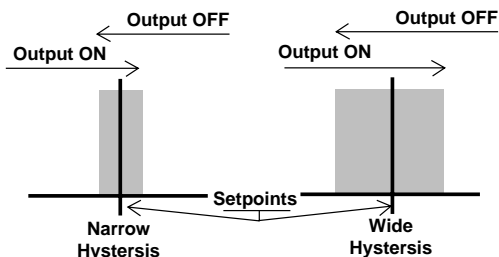

Deadband/Overlap

$$\frac{\text{Prop. Band for Heating X Input Range}}{100\%} = \frac{\text{\# of units in the Proportional Band for Heating}}{100\%}$$

$$\frac{\text{Prop. Band for Cooling X Input Range}}{100\%} = \frac{\text{\# of units in the Proportional Band for Cooling}}{100\%}$$

$$\frac{\text{Deadband/Overlap X Input Range}}{100\%} = \frac{\text{\# of units in the Deadband/Overlap}}{100\%}$$

Input Range= (P-SU minus P-SL)

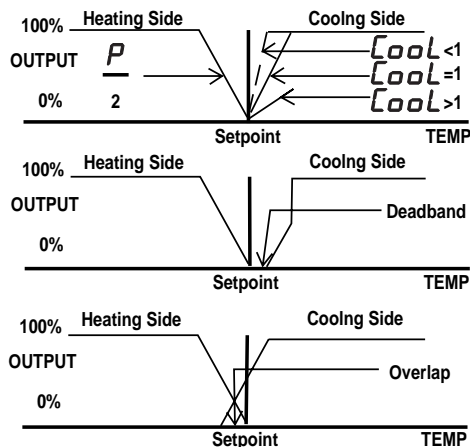

ing and cooling outputs are energized at the same time, for less powerful heating and cooling loads. Enter a value based on the power of your heating and cooling loads as well as the application's efficiency in maintaining tight heat/cool control. Setting range: -50.0 to 50.0% of the heating proportional band. Not indicated without control output #2 option

bAL bAL Balance: Balance is used to pre-position the proportional band with respect to setpoint. With Balance (MV Offset) set at 50% the proportional band will be centered around setpoint. To move the band left or right, decrease or increase the balance setting respectively. Setting range: 0-100%

Ar Ar Anti-Reset Wind-up: Anti-Reset is used to limit the range where integration occurs. This helps in stabilizing a system. With Anti-Reset at 100%, integration will occur throughout the proportional band. With Anti-Reset set to 90%, integration will occur at 90% of the band above the setpoint and 90% of the band below the setpoint. Autotuning automatically sets Ar. Setting range: 0-100% of full scale, set in E.U.

P-n2 P-n2 Input type: The Input Type is the type of sensor to be used with the controller in sensing the process variable. The Input Type must be correctly programmed into the controller in order for the controller to perform with the selected sensor type. Depending on the type of sensor to be used, the controller comes in two models. One model accepts J, K, R, B, S, T, E, N thermocouples and RTDs (Pt100). The other model accepts 1-5/0-5V DC and 4-20/0-20mA DC signals. The current/voltage model comes with a 250Ω preci-

TC2 TC2 Cycle Time (Output #2) The Cycle Time for output #2 is similar in function to Cycle Time for output #1. Output #2 is the cooling side of a heat/cool PXW controller. Enter a value that is based on the limitations of your controller's output type. Setting Range: 1 to 150 secs. Not indicated without the control output #2 option For current output: Set to 0 (normally not indicated)

Cool Cool Proportional Band Coefficient for Cooling: The Proportional Band Coefficient for Cooling is a multiplier for the proportional band on the cooling side of a heat/cool controller. It varies the width of the proportional band on the cooling side. A large value would establish a larger proportional band for more powerful cooling loads. A small value would establish a smaller proportional band for less powerful cooling loads. Enter a value based on the power of your cooling load. Setting Range: 0.0 to 100.0 Not indicated without control output #2 option. Set to "0" for On/Off control.

$$\text{Prop. Band for Heating X Input Range} = \frac{P}{2}$$

$$\text{Prop. Band for Cooling X Input Range} = \frac{P}{2} \times \text{Cool}$$

$$\text{Deadband/Overlap X Input Range} = \frac{P}{200\%} \times \text{db}$$

db db Deadband/Overlap: The Deadband/Overlap is that percentage of the heating side of the proportional band where the heating (output #1) and the cooling (output #2) outputs are separated by a Deadband or where they Overlap on a heat/cool controller. A value greater than zero establishes a Deadband area where neither the heating nor cooling outputs are energized, for more powerful heating and cooling loads. A value less than zero establishes an Overlap area where both the heat-

sion resistor. Wired directly to the controller, it would convert a current signal into a voltage signal. There is no need to use the resistor if a voltage signal is applied directly.

After the appropriate physical changes have been made, the controller still needs the correct code for the Input Type to be used. Enter the appropriate code from the Table of Input Type Codes.

Table of Input Type Codes

Input Signal	Code	Range of measurement (°C)	Range of measurement (°F)	With decimal point (°C)	With decimal point (°F)	
RTD (IEC)	Pt100Ω	1	0 to 150	32 to 302	O	O
	Pt100Ω	1	0 to 300	32 to 572	O	O
	Pt100Ω	1	0 to 500	32 to 932	O	O
	Pt100Ω	1	0 to 600	32 to 1112	O	X
	Pt100Ω	1	-50 to 100	-58 to 212	O	O
	Pt100Ω	1	-100 to 200	-148 to 392	O	O
	Pt100Ω	1	-150 to 600	-238 to 1112	O	X
	Pt100Ω	1	-150 to 850	-238 to 1562	X	X
Thermocouple	J	2	0 to 400	32 to 752	O	O
	J	2	0 to 800	32 to 1472	O	X
	K	3	0 to 400	32 to 752	O	O
	K	3	0 to 800	32 to 1472	O	X
	K	3	0 to 1200	32 to 2192	X	X
	R	4	0 to 1600	32 to 2912	X	X
	B	5	0 to 1800	32 to 3272	X	X
	S	6	0 to 1600	32 to 2912	X	X
	T	7	-199 to 200	-328 to 392	O	X
	T	7	-150 to 400	-238 to 752	O	X
	E	8	-0 to 800	32 to 1472	O	X
	E	8	-199 to 800	-328 to 1472	O	X
	N	12	0 to 1300	-32 to 2372	X	X
DC current/voltage	0-20mA/ 0-5V	15	-1999 to 9999 (Scaling is possible)	O= Enabled X=Disabled		
	4-20mA/ 1-5V	16				

the Upper Limit of Input Range setting by 5% of full scale. The primary purpose of the upper limit when used with a thermocouple or RTD input is to limit setpoint settings. Making the input range smaller does not increase the accuracy. The primary purpose of the Upper Limit of Input range when used with 1-5/0-5V DC or 4-20/0-20mA DC signal input is to scale the range so that 5V DC on a 1-5/0-5VDC signal and 20mA DC on a 4-20/0-20mA DC signal equals the high limit of the engineering unit range used. The engineering unit range could be %, PSI, PH, or any range which can be scaled between -1999 and 9999 units.

Enter a value to set Upper Limit of Input range based on the type of input used.

SCALING THERMOCOUPLE AND RTD(Pt100) INPUT RANGES

Example: Program a J thermocouple for 50 to 500°F

Input Type	Minimum/Maximum Range
J Thermocouple	32 1472 °F

Program P-SL to 50
P-SU to 500

Full Range = (500-50) = 450 F

P-SL Lower Limit of Input Range: The Lower Limit of Input Range is that value which establishes the desired low limit for the type of input used. The value must be greater than or equal to the input type's lowest limit. Setpoint settings are restricted to values greater than the low limit. Parameters which are calculated as a percentage of full scale are affected by this setting. An underscale error message is indicated on the process variable display when the process variable goes below the Lower Limit of Input Range setting by 5% of full scale. The primary purpose of the Lower Limit of Input Range when used with a thermocouple or RTD sensor input is to limit setpoint settings. Making the input range smaller does not increase the accuracy. The primary purpose of the Lower Limit of Input range when used with 1-5/0-5V DC or 4-20/0-20mA DC signal input is to scale the range so that 1/0V DC on a 1-5/0-5V DC signal and 4/0mA DC on a 4-20/0-20mA DC signal equals the low limit of the engineering unit range used. The engineering unit range could be %, PSI, GPM, PH, or any range which can be scaled between -1999 and 9999 units. Enter a value to set Lower Limit of Input range based on the type of input used.

P-SU Upper Limit of Input Range: The Upper Limit of Input Range is that value which establishes the desired high limit for the type of input used. The value must be less than or equal to the input type's highest limit. Setpoint settings are restricted to values less than the high limit. Parameters which are calculated as a percentage of full scale are affected by this setting. An over-scale error message is indicated on the process variable display when the process variable goes above

SCALING DC CURRENT/VOLTAGE INPUT RANGES

Example: Program a 4-20mA DC signal for 0 to 100 E.U.

Input Type	Minimum/Maximum Range
4-20mA DC	-1999 . . . 9999 Engineering Units

Program P-SL to 0
P-SU to 100

Full Range = (100-0) = 100 Engineering Units

P-dP Decimal Point Position (Resolution): The Decimal Point Position is the resolution at which the controller displays the process variable and other parameter values. The display can indicate integers, tenths or hundredths of a unit. The Decimal Point Position does not increase the accuracy of the controller, it only increases the resolution. For a thermocouple, integers are usually sufficient due to the accuracy rating and the programmed input range. For a RTD (Pt100), integers or tenths of a degree may be entered, because of the increased accuracy of these sensors, depending on the programmed input range. For a 1-5/0-5V DC or 4-20/0-20mA DC signal, integers, tenths or hundredths of a unit may be entered depending on the programmed input range.

Setting:
0 -None
1- Tenths of a unit
2 - Hundredths of a unit

P - AH P-AH
P - AL P-AL

Alarm Type 1:

Alarm Type 2: These functions set the control action for the optional alarm output relays. They can be programmed for absolute, deviation, combination, or zone alarm configuration. The high and low alarm setpoints are set with primary menu parameters AH and AL (AL is not applicable in the case of PXV3). The absolute alarm configurations are independent of main setpoint. The alarm output relays are energized when the process variable exceeds the alarm setpoint, an absolute value. The deviation alarm configuration is main setpoint tracking. The alarm output relays are energized when the process variable exceeds the main setpoint by a deviation value set by AL or AH. The combination alarm configurations are a mixture of both the deviation and absolute value settings for the high and low alarms. With zone alarm configurations the alarm output is energized between the range set by AL and AH.

One of the alarm types is Alarm with Hold. In this case the alarm is not turned on the first time the measured value is in the alarm band. Instead it turns on only when the measured value goes out of the band and enters it again. This type is useful when using deviation alarm with step type input.

Enter the code for P-AH and P-AL from the Table of Alarm Action Type Codes. See Figures below.

P-AL is not applicable in the case of PXV3.

Note 1: A change of alarm action type can cause the alarm set value to change, but this is not a malfunction.
Note 2: After the alarm type is changed, turn off the power to the unit once.

Table of Alarm Action Type Codes—PXW

	ALM1 (P-AH)	ALM2 (P-AL)	Alarm type	Action diagram
	0	0	No alarm	
Absolute value alarm	1	1	High alarm	
	2	2	Low alarm	
	3	3	High alarm (with hold)	
	4	4	Low alarm (with hold)	
Deviation alarm	5	5	High alarm	
	6	6	Low alarm	
	7	7	High/Low alarm	
	8	8	High alarm (with hold)	
	9	9	Low alarm (with hold)	
	10	10	High/Low alarm (with hold)	
Zone alarm	11	11	High/Low deviation alarm (ALM 1/2 independent action)	
	—	12	High/Low absolute alarm	
	—	13	High/Low deviation alarm	
	—	14	High absolute/ Low deviation alarm	
	—	15	High deviation/ Low absolute alarm	

Table of Alarm Action Type Codes—PXV3

	Code (P-AH)	Alarm type	Action diagram
	0	No alarm	
Absolute value alarm	1	Absolute upper limit	
	2	Absolute lower limit	
	3	Absolute upper limit (with hold)	
	4	Absolute lower limit (with hold)	
Deviation alarm	5	Upper limit deviation	
	6	Lower limit deviation	
	7	Upper and lower limit deviation	
	8	Upper limit deviation (with hold)	
	9	Lower limit deviation (with hold)	
	10	Upper and lower limit deviation (with hold)	
Range alarm	11	Deviation from upper and lower limit of a range	

PVOF PVOF Process Variable Offset: The Process variable Offset is the amount by which the indicated process variable is shifted in a positive or negative direction. Both the indicated as well as the measured process variable will be changed. This parameter can be used to correct for differences in sensors, sensor placement, and standardization problems. Enter a value which is the difference between the measured process value and the actual process value of the system.
Setting range: -10 – 10% of full scale, set in Eng. units.

SVOF SVOF Setpoint Variable Offset: The Setpoint Variable Offset is that amount of offset which shifts the measured setpoint variable in a positive or negative direction. The measured setpoint variable is changed but the indicated setpoint variable remains unchanged. Be careful when using this variable because what you see as the setpoint variable may be very different from the actual setpoint variable.
Setting range: -50 – 50% of full scale, set in Eng. units.
Indicated Setpoint Variable is Unchanged
Measured Setpoint Variable is Changed

P-F P-F C/F Selection: The C/F Selection allows choosing either the Celsius or the Fahrenheit scale. If using the controller to control a process other than temperature using the current/voltage input model, the C/F Selection is not important because the scaling is done using the lower limit of the input range and upper limit of input range parameters. If using the thermocouple/RTD (Pt100) input model, however, the C/F Selection is important in scaling the controller's parameters.
Setting: °C or °F

5787 STAT **Ramp/Soak Status:** The Ramp/Soak program automatically changes the setpoint value with time in accordance with a preset pattern, as shown in the figure. This device allows a maximum of four ramp and four soak segments. Ramp is the region in which SV changes toward the target value. Soak is the region in which the target value is maintained. STAT displays the current ramp/soak status. No setting can be made.

oFF: Not in operation
 1-rP – 4-rP: Executing 1st – 4th ramp
 1-St – 4-St: Executing 1st – 4th soak
 End: End of program

50-1 SV-1 **Ramp Target Value:** Sets the target value for each ramp to segment.

50-4 SV-4 Setting range: 0-100% of full scale

701- TM1r **Ramp Segment Time:** Sets the duration of each ramp to segment.

704- TM4r Setting range: 00.00 to 99hrs 59mins.

705- TM1S **Soak Segment Time:** Sets the duration of each soak to segment.

705- TM4S Setting range: 00.00 to 99hrs 59mins.

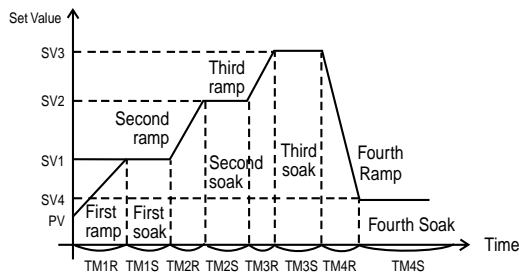

Ramp: Region in which the setpoint changes toward the target value.
Soak: Region in which the setpoint stays unchanged at the target value.

Note 1: SV cannot be changed while the operation is running or suspended.
Note 2: The use of fuzzy control is inhibited while Ramp-Soak operation is being performed.

Mod **Ramp/Soak Mode:** Up to 16 different modes of ramp/soak operations are possible. Choose the appropriate code from the Table of Ramp/Soak Modes
 Setting: 0-15

Table of Ramp/Soak Modes

MOD	Power on start	Output on END	Output on OFF	Repeat function
0	No	Going on control	Going on control	No
1	No	Going on control	Going on control	Yes
2	No	Going on control	Stand-by mode	No
3	No	Going on control	Stand-by mode	Yes
4	No	Stand-by mode	Going on control	No
5	No	Stand-by mode	Going on control	Yes
6	No	Stand-by mode	Stand-by mode	No
7	No	Stand-by mode	Stand-by mode	Yes
8	Yes	Going on control	Going on control	No
9	Yes	Going on control	Going on control	Yes
10	Yes	Going on control	Stand-by mode	No
11	Yes	Going on control	Stand-by mode	Yes
12	Yes	Stand-by mode	Going on control	No
13	Yes	Stand-by mode	Going on control	Yes
14	Yes	Stand-by mode	Stand-by mode	No
15	Yes	Stand-by mode	Stand-by mode	Yes

1. Power on Start: Program starts from the current PV value.
2. Output on END: Output condition at the end of the program (rEnd)
3. Output on OFF: Output condition when program is terminated (roFF)
4. Repeat function: Ramp-soak program operates repeatedly.

If the repeat function is off, the SV value on the last step is maintained.

Stand-by mode: Output -3%, Alarm off.
 Going on Control: When program ends (rEnd), control is at the SV value on the last step.
 When program is terminated (roFF), control is at the main SV value.

FACTORY PRESET MENU

P-n1 P-n1 **Control Action & Sensor Burn-out Protection:** The Control Action is the direction of the output relative to the process variable. The controller can be programmed for either reverse or direct control action. In a reverse acting controller, the output decreases as the process variable increases. A heating application would require reverse acting control. In a direct acting controller, the output increases as the process variable increases. A cooling application would require direct acting control. Enter the code from the Table of Output Type Codes which establishes either a reverse or direct control action.

The Sensor Burn-out Protection is the intended direction of the output in the event of a thermocouple or RTD sensor break, or a break in the analog input. The controller can be programmed with either upper-limit or lower-limit burn-out direction. With Upper-limit Burn-out, a 100% output will be delivered in the event of a sensor burn-out. With Lower-limit Burn-out, 0% output will be delivered in the event of a sensor burn-out. Enter the appropriate code from the Table of Output Type Codes.

Refer to Error Messages for more details.

Table of Output Type Codes

Code	Output type	Control action		Burn-out direction		
		Output 1	Output 2	Output 1	Output 2	
0	Single	Reverse action	---	Lower limit	---	
1				Upper limit		
2		Direct action		Lower limit		
3				Upper limit		
4	Dual	Reverse action	Direct action	Lower limit	Lower limit	
5				Upper limit	Upper limit	
6				Lower limit	Upper limit	
7				Upper limit	Lower limit	
8		Direct action		Lower limit	Lower limit	
9				Upper limit	Upper limit	
10				Lower limit	Upper limit	
11				Upper limit	Lower limit	
12		Reverse action	Reverse action	Lower limit	Lower limit	
13				Upper limit	Upper limit	
14				Lower limit	Upper limit	
15				Upper limit	Lower limit	
16				Direct action	Lower limit	Lower limit
17					Upper limit	Upper limit
18					Lower limit	Upper limit
19					Upper limit	Lower limit

Fuzzy FUZY Fuzzy Logic Control: Employing Fuzzy Logic Control in addition to PID control eliminates system overshoot and effectively suppresses fluctuation of the process variable due to external disturbances. This function may be enabled even during auto-tuning. Note that fuzzy control is not effective in units with dual outputs, due to the complexity of the process. Fuzzy control is also inhibited while the Ramp/Soak function is in operation.

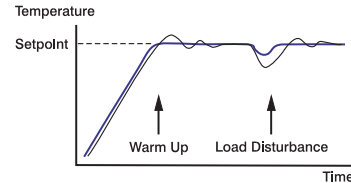

ADJO ADJO Input Calibration: This function is used for input calibration by the user in a simple manner. Calibration is effected by first applying the appropriate signal for zero and span points of the input range being used and then by correcting the errors. The user calibration function is an independent function and the instrument can easily be reset to conditions prior to delivery.

ADJS ADJS
Example:
 Input range 0-400°C
 Indication at 0°C : -1°C
 Indication at 400°C: 402°C
 Change ADJO to 1 and ADJS to -2 to correct the error. The instrument can be set back to factory values by setting ADJO and ADJS to 0.

dSP1 dSP1 Parameter Mask function: This function is used to individually mask the display of parameters that are not used for your application, or parameters that are not to be accessed by the operator. To mask or unmask a parameter, appropriate values should be selected from the DSP Assignment table.

- Example 1:** To mask parameter P
- Determine the dSP value for P from Quick Reference
P = dSP1 – 128
 - Add 128 to the existing dSP1 value.
- Example 2:** To display/unmask the parameter P-F
- Determine the dSP value for P-F from Quick Reference
P-F = dSP4 – 2
 - Subtract 2 from the existing dSP4 value.

P-dF P-dF Input Filter Constant: The Input Filter is used to filter out the quick changes that occur to the process variable in a dynamic or quick responding application which causes erratic control. By slowing down the response time, the PXW controller averages out the peaks and valleys of a dynamic system which, in turn, stabilizes the control. The digital filter also aids in controlling processes where the electrical noise is affecting the input signal. The larger the value entered, the more filter added and the slower the controller reacts to process variable changes. The smaller the value entered, the less filter added and the quicker the controller reacts to process variable changes. Enter as small a value as possible that provides accurate and stable control.
 Setting range: 0.0-900.0 secs

P-An P-An Alarm Hysteresis: The Alarm Hysteresis is that area on one side of the alarm setpoint where the output does not change condition. That area or deadband is intended to eliminate relay chatter at alarm setpoint with less wear on the relay. With a wide Alarm Hysteresis, the controller takes a longer time to change output condition. With a narrow Alarm Hysteresis, the controller takes a short time to change output condition. Enter a value which is just large enough to eliminate relay chatter.
 Setting Range: 0 to 50% of full scale, set in E.U.

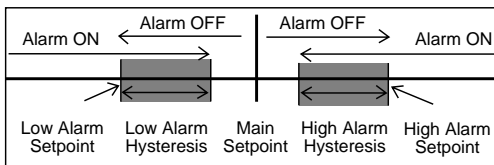

ERROR MESSAGES

Error Indication	Cause	Control Output
UUUU	1. Thermocouple burnt out. 2. RTD (A) leg burnt out. 3. PV value exceeds P-SU by 5% FS.	When the burn-out control output is set for lower limit (standard): OFF, or 4mA or less.
LLLL	1. When RTD (B or C) is burnt out. 2. When RTD (between A and B, or between A and C) is shorted. 3. When PV value is below P-SL by 5% FS. 4. When analog input wiring is open or short.	When the burn-out control output is set for upper limit: ON, or 20mA or less.
LLLL	When PV value goes below -1999.	Control is continued until the value reaches -5% FS or less, after which burn-out condition will occur.
HB lamp ON	Heater break condition	Normal control output for heating is continued.
Err	When the setting of P-SL/P-SU is improper	OFF, or, 4mA or less.
FAULT	Fault in the unit	Undefined. Stop use immediately.

APPENDIX A

Autotuning

By autotuning, the controller selects what it calculates to be the optimal PID control parameters for a particular process and then stores them in EEPROM memory for future use. The PID parameters are stored so that when the controller is powered up after being shut down, the controller does not need to be autotuned again. The controller uses the same autotuned PID parameters until the Autotune function is again initiated. The Autotune parameters are only good for the process the Autotune function was used on. If the setpoint is significantly changed, the input sensor is changed, the load or output device is changed or relocated, or any other disturbances occur which might change the dynamics of the system, the Autotune function should be performed again. The autotuned control parameters are not always perfect for every application but almost always give the operator a good starting point from which further refinement of the control parameters can be performed manually.

The autotuning algorithm used here is particularly suited for temperature control applications and may not always autotune effectively for other processes. Here are cases where the Autotune function does not perform well or does not perform at all:

1. The system is affected by process disturbances external to the control loop. Adjacent heater zones, changing material levels, exothermic reactions are examples of process disturbances which are external to the control loop. The controller would never be able to autotune such an unstable process.
2. The system is very dynamic. The process variable changes very quickly. Certain pressure and flow applications would be characterized as very dynamic. Because of how the Autotune function is performed, a very dynamic system would create very large overshoots which could damage the process.
3. The system is very insulated and cannot cool down in a timely manner. With such heating systems the autotuning function would take a long time to complete, with questionable results.

During autotuning test signals are sent to the process. The test signals are 100% output and 0% output at the Autotune point. The Autotune point can either be at setpoint or 10% of full scale below setpoint.

The controller performs as an On/Off controller. See diagram below.

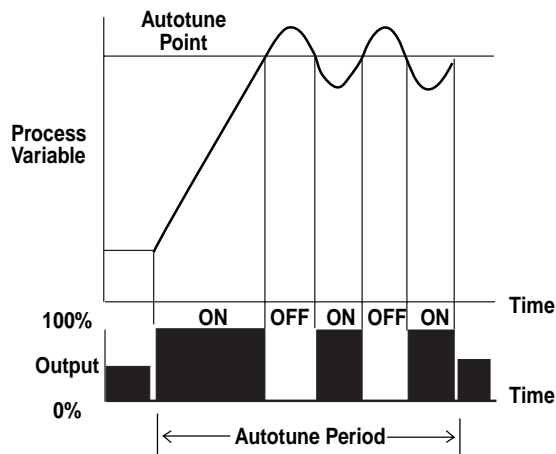

The controller then reads the reaction of these test signals on the process. Keep in mind that every process is different and therefore every reaction to the test signals is different. This is why PID parameters are not the same for all processes. The amplitude (L) or lag time which is the overshoot and undershoot of the system when autotuning, and the time constant (T) which is the time the process takes to go through one On/Off cycle are measured. See diagram below.

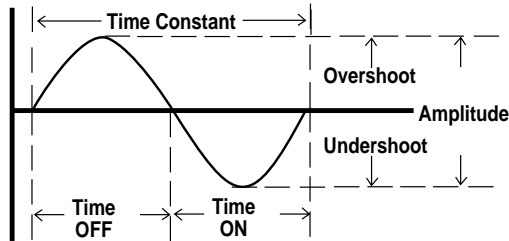

The measurements are then used with the Autotune algorithm for calculation of the proper PID parameters for the system, as shown below, where K is the proportionality constant and S is the Laplace operator.

$$\frac{K}{(1+TS)} e^{-LS}$$

APPENDIX B

Manual Tuning

Tune the controller if any of the following occurs:

- The controller is installed in a new system
- The controller is used as a replacement in an existing system
- The input sensor is relocated or changed
- The output device is relocated or changed
- The setpoint is significantly changed
- Any other condition that will alter the dynamics of the system

Proportional Band

The proportional band is a band around the setpoint of the PXW where the output is between 0% and 100%. The percentage of output is proportional to the amount of error between the setpoint variable (SV) and the process variable (PV). Outside of the proportional band the output is either 0% or 100%.

The proportional band on PXV3/PXW is equidistant from the main setpoint as illustrated below.

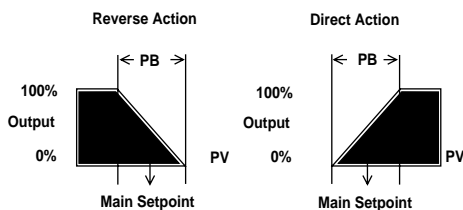

An example of proportioning would be a vehicle approaching a stop sign at an intersection. If the driver were traveling at 50mph and only applied his brakes once at the intersection, his car would skid through the intersection before coming to a full stop. This illustrates how On/Off control acts. If, however, the driver started slowing down some distance before the stop sign and continued slowing down at some rate, he could conceivably come to a full stop at the stop sign. This illustrates how proportional control acts. The distance where the speed of the car goes from 50 to 0 MPH illustrates the proportional band. As you can see, as the car travels closer to the stop sign, the speed is reduced accordingly. In other words, as the error or distance between the car and the stop sign becomes smaller, the output or speed of the car is proportionally diminished. Figuring out when the vehicle should start slowing down depends on many variables such as speed, weight, tire tread, and braking power of the car, road conditions, and weather much like figuring out the proportional band of a control process with its many variables.

The width of the proportional band depends on the dynamics of the system. The first question to ask is, how strong must my output be to eliminate the error between the setpoint variable and process variable? The larger the proportional band (low gain), the less reactive the process. A proportional band too large, however, can lead to process wandering or sluggishness. The smaller the proportional band (high gain), the more reactive the output becomes. A proportional band too small, however, can lead to over-responsiveness leading to process oscillation.

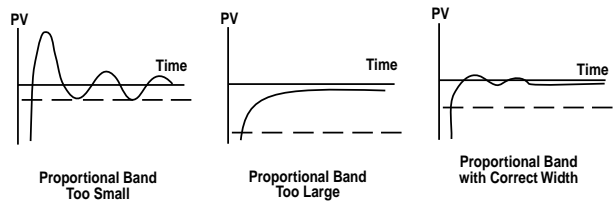

A proportional band which is correct in width approaches main setpoint as fast as possible while minimizing overshoot. If a faster approach to setpoint is desired and process overshoot is not a problem, a smaller or narrower proportional band may be used. This would establish an over-damped system or one where the output would change greatly, proportional to the error. If process overshoot cannot be tolerated and the approach to setpoint does not have to be quick, a larger or wider proportional band may be used. This would establish an under-damped system or one where the output would change little, proportional to the error.

To Calculate Proportional Band:

$$\text{Proportional Band (as a percentage)} = \frac{\text{Proportional Band}}{\text{Input Range}} \times 100\%$$

Example:

$$3\% = \frac{30^\circ\text{C}}{100^\circ\text{C}} \times 100\%$$

$$\text{Proportional Band Range} = \frac{\text{Proportional Band (as a percentage)}}{100\%} \times 1000^\circ\text{C}$$

Example:

$$30^\circ\text{C} = \frac{3\%}{100\%} \times 1000^\circ\text{C}$$

Integral Time

With the proportional band alone, the process tends to reach equilibrium at some point away from the main setpoint. This offset is due to the difference between the output needed to maintain setpoint and the output of the proportional band at setpoint. Since the proportional band is equidistant from the main setpoint, the output is around 50%. If anything more or less than 50% output is required to maintain setpoint, an offset error will occur. Integral action eliminates this offset. See the diagrams below.

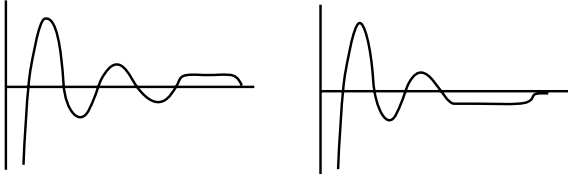

Integral action eliminates offset by adding to or subtracting from the output of the proportional action alone. This increase or decrease in output corrects for offset error within the proportional band in establishing steady-state performance at setpoint. It is not intended to correct for process disturbances. See the following diagram.

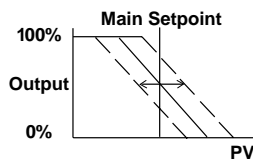

Integral Time is the speed at which the controller corrects for offset. A short integral time means the controller corrects for offset quickly. If the integral time is too short, the controller would react before the effects of previous output shifts—due to lead or lag time—could be sensed, causing oscillation. A long Integral time means the control corrects for offset over a long time. If the integral time is too long, the offset will remain for some time causing a slow responding or sluggish control. See the diagram below.

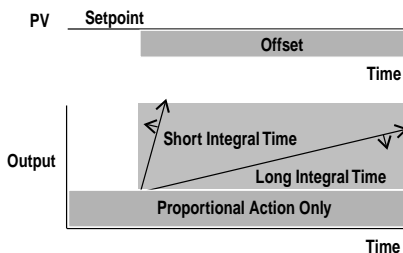

Derivative Time

In the case of a process upset, proportional only or proportional-integral action cannot react fast enough in returning a process back to setpoint without overshoot. The derivative action corrects for disturbances providing sudden shifts in output which oppose the divergence of the process from setpoint. See the diagram below.

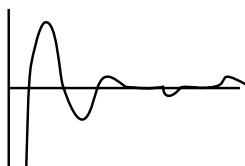

The derivative action changes the rate of reset or integration proportional to the rate of change and lag time of the system. By calculating the rate of change of the process and multiplying it by the lag time which is the time it takes the controller to sense an output change, the controller can anticipate where the process should be and change the output accordingly. This anticipatory action speeds up and slows down the effect of proportional only and proportional-integral actions to return a process to setpoint as quickly as possible with minimum overshoot. See the diagram below.

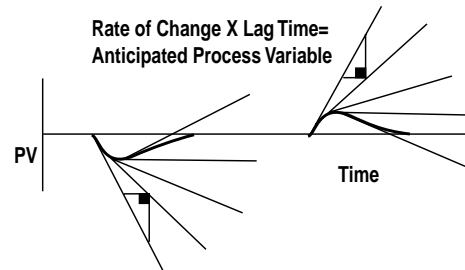

Derivative time is the amount of anticipatory action needed to return a process back to setpoint. A short derivative time means little derivative action. If the derivative time is too short, the controller would not react quickly to process disturbances. A long derivative time means more derivative action. If the derivative time is too large, the controller would react too dramatically to process disturbances creating rapid process oscillation. A process which is very dynamic such as pressure and flow applications is more efficiently controlled if the derivative action is turned off because of the oscillation problem which would result.

Tuning

Tuning, as with any PID loop, requires tuning each parameter separately and in sequence. To achieve good PID control manually, you can use the trial and error method explained below.

Tune the Proportional Band

Set Integral Time = 0 (off)

Set Derivative Time = 0 (off)

Start with a large Proportional Band value which gives very sluggish control with noticeable offset and tighten by decreasing the value in half. Analyze the process variable. If the control is still sluggish, tighten by decreasing the value in half again. Continue with the same procedure until the process starts to oscillate at a constant rate. Widen the Proportional Band by 50%, or multiply the setting 1.5 times. From a cold start, test and verify that the Proportional Band allows maximum rise to setpoint while maintaining minimum overshoot and offset. If not completely satisfied, fine-tune the value, up or down, as needed and test until correct. The Proportional Band is now tuned.

Add Integral Time

Start with a large Integral Time value which gives very sluggish response to process offset and tighten by decreasing the value in half. Analyze the process variable. If the response to process offset is still sluggish, tighten by decreasing the value in half again. Continue with the same procedure until the process starts to oscillate at a constant rate. Increase the Integral Time value by 50%, or multiply the setting 1.5 times. From a cold start, test and verify that the Integral Time allows maximum elimination of offset with minimum overshoot. If not completely satisfied, fine-tune the value, up or down, as needed and test until correct. The Integral Time is now tuned.

Add Derivative Time

Do not add Derivative Time if the system is too dynamic. Start with a small Derivative Time value which gives sluggish response to process upsets and double the value. Analyze the process variable. If the response to process upsets is still sluggish, double the value again. Continue with the same procedure until the process starts to oscillate at a quick constant rate. Decrease the Derivative Time value by 25%. From a cold start, test and verify that the Derivative Time value allows maximum response to process disturbances with minimum overshoot. If not completely satisfied, fine-tune the value, up or down, as needed and test until correct. Note that the Derivative Time value is usually somewhere around 25% of the Integral Time value. The derivative Time is now tuned.

Another tuning method is the closed-loop cycling or Zeigler-Nichols method. According to J.G. Zeigler and N.B. Nichols, optimal tuning is achieved when the controller responds to a difference between setpoint and the process variable with a 1/4 wave decay ratio. That is to say that the amplitude of each successive overshoot is reduced by 3/4 until stabilizing at setpoint. The procedure is explained below.

1. Integral Time=0
Derivative Time=0
2. Decrease the Proportional Band to the point where a constant rate of oscillation is obtained. This is the response frequency of the system. The frequency is different for each process.
3. Measure the Time Constant which is the time to complete one cycle of the response frequency. The Time Constant will be defined as "T" when calculating Integral and Derivative Times.

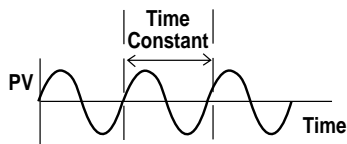

4. Widen the Proportional Band until only slightly unstable. This is the Proportional Band's Ultimate Sensitivity. The Proportional Band's Ultimate Sensitivity width will be defined as "P" when calculating the actual Proportional Band.
5. Use the following coefficients in determining the correct PID settings for your particular application.

Control Action	P Setting	I Setting	D Setting
P Only	2P	*	*
PI	2.2P	.83T	*
PID	1.67P	.5T	.125T

APPENDIX C

Heater Break Option

The Heater Break Option is used to detect heater break conditions and to energize an alarm relay when such conditions exist. In most cases, the option is used to detect the failure of one or more zones in a multi-zoned heater where all individual resistive heater zones are wired in parallel. Failed heater zones would create cold spots in a system which could hamper the process and even ruin the product. If cold spots in a system are a problem, the Heater Break option is an effective way of alerting the operator of a heater break condition, a cause of cold spots.

The PXW controller is able to detect a heater problem by analyzing the current used by the heater. The actual sensing is done by a current sensing transformer, sold separately, which is placed around the hot lead going to the heater and connected to the controller. The signal sent by the current sensing transformer is timed with the output of the PXW. When the output is energized the signal sent from the current sensing transformer is analyzed. When the output is de-energized the signal sent from the current sensing transformer is not analyzed. This eliminates the alarm condition turning on and off due to the output condition of the controller. If the signal sent when the output is energized indicates that the current level is below what the Heater Break alarm is set for, the alarm is energized. The alarm is non-latching.

Notes:

1. The Heater Break Option is available on the PXW-5, 7, and 9 controllers only.
2. The Heater Break Option cannot be used on the PXW controller with a 4-20mA DC output. The current sensing transformer would pick up current changes due to fluctuating power output, between 0% and 100%, which would result in a heater break alarm condition even though no such condition existed.
3. The Cycle Time must be set at 6 secs. or higher in order for the controller to correctly analyze the signal sent by the current sensing transformer.
4. The power supply used should be the same for the PXW and heater to eliminate current fluctuations due to power differences between different power supplies.

Wiring and Setting:

1. Choose the correct current sensing transformer based on the maximum current usage of the heater.
0 - 30 Amps (part # CTL-6-SF)
20 - 50 Amps (part # CTL-12-S36-8F)
2. Thread the hot lead going to the heater through the donut of the current sensing transformer. Connect the wires of the current sensing transformer to the current sensing transformer input terminals in the back of the controller.

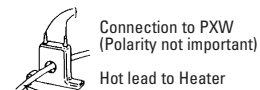

3. Set Heater Break alarm setpoint parameter, "Hb".

With the current sensing transformer connected and the heater in operation (output energized), change the Heater Break Alarm setting from the maximum current setting for the particular current sensing transformer being used to a lower value. Allow 3 secs. or more between setting changes. Continue lowering the setting until the relay is energized and the "HB" status indicator is lit. This is the maximum current usage of the heater. Using the same procedure, find the maximum current usage of the heater minus one zone. Set the setpoint in between the two current readings. In this way, the operator knows if one or more zones fail because the current sensed will only be below the Heater Break Alarm setting if one or more zones fail.

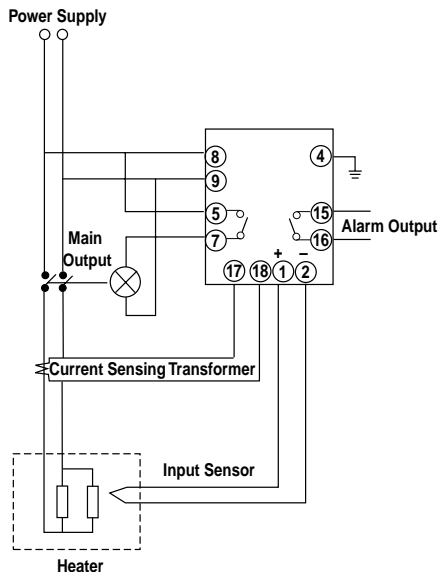

db Deadband/Overlap: Deadband is that area where neither outputs are energized. Overlap is that area when both outputs are energized. This function lets you decide where you want the heating action to stop and the cooling action to begin.

Notes:

1. The Heat/Cool Option is available on the PXW-5, 7, and 9 controllers only. Output #2 type can be the same or different than Output #1 type (Relay, SSR driver, or 4-20mA DC)
2. Integral and Derivative Times are the same for both the heating and cooling sides of a process with PID control because the response frequency or time constant of the system does not change at main setpoint when cooling is added.
3. The Proportional Band for heating and cooling are almost always different. Rarely does the same amount of cooling output remove the same percentage of process error as the heating output does. The Cooling Proportional Band must be manually and separately tuned.
4. If the heating side is set for On/Off control, the cooling side will be set for On/Off control also. Regardless of what the COOL parameter is set for, if the Proportional Band is set to zero, the Heating Proportional Band and the Cooling Proportional Band will always be zero or On/Off.
5. If the cycle times of one or both outputs are long and the process dynamic, there is a good chance that both outputs will be cycling on and off at the same time around main setpoint. This is evident if one or both outputs are relays.
6. Autotune is not effective on the cooling side of Heat/Cool control. Autotune the controller for heat only and then manually tune the cooling parameters.

APPENDIX D

Heat/Cool Option

With the Heat/Cool Option, the PXW can control a temperature application with one input at one main setpoint using two outputs, a heating output and a cooling output. By using a heating and cooling output, a process is able to quickly bring the temperature to setpoint in both directions and to limit the amount of overshoot. The larger the deviation from setpoint, the more output applied to the system on both the heating and cooling sides. Heat/Cool control is a very effective way of controlling exothermic processes, processes that generate their own heat, or processes where ambient temperature is not adequate or fast enough in returning a process back to setpoint.

The two outputs on the PXW are independent and sent to two different output devices. The PXW can be equipped with two of the same or two different output types. Output #2 can be relay, SSR driver, or 4-20mA DC, regardless of what Output #1 is. Both output types must be specified when ordering.

The PXW controls the cooling side with three additional parameters, TC-2, COOL, and DB as explained in the programming section.

TC2 **Cycle Time (Output #2):** Because Output #2 is not necessarily the same as Output #1, the cycle time may be different.

Cool **Proportional Band Coefficient for Cooling:** Because the cooling power may not necessarily be the same as the heating power, the cooling proportional band may be different from that of the heating proportional band.

Wiring and Setting

1. Make sure that your PXW has the correct output type installed for Output #2. Verify that the TC2, COOL, and DB parameters are indicated in the primary (setpoint) menu.
2. Wire your cooling load to the Output #2 terminals located on the back of your PXW controller.
3. In the secondary (system) menu, program the correct code for Heat/Cool action. See Table of Output Type Codes.
4. In the primary (setpoint) menu, program TC2, the cycle time for Output #2. The table below is a general guide to TC2 settings.

Output#2 Type	Setting(Secs)
Relay	30
SSR Driver (pulsed DC)	2
4-20mA DC	Not indicated or 0

5. Autotune or manually tune the PID parameters of your PXW controller. Autotune will work for the heating PID parameters but not on the cooling parameters. You must manually tune the cooling parameters.
6. With the heat side tuned, manually set the COOL parameter or Proportional Band Coefficient for Cooling. If the cooling output is

less powerful than the heating output, the Cooling Proportional Band must be narrower than the Heating Proportional Band; the COOL parameter would be less than "1". If the cooling output is more powerful than the heating output, the Cooling Proportional Band must be wider than the Heating Proportional Band; the COOL parameter would be more than "1". See the programming section for more details.

Heating Side	Cooling Side
Heating Proportional Band [P/2]	Cooling Proportional Band [P/2 COOL]
I	I (same as for heating)
D	D (same as for heating)

7. Finally, you can add a Deadband/Overlap. The programmed Deadband/ Overlap parameter can be within -50% to +50% of the Heating Proportional band. To establish a Deadband, parameter "db" is set somewhere between 0% and 50% of the Heating Proportional band. To establish an Overlap, db is set somewhere between -50% and 0% of the Heating Proportional Band.
8. Manually fine-tune the parameters, Cool and db, until just the right amount of cooling is achieved. Refer to the programming section for more details on these parameters.

PXW/PXV3 QUICK REFERENCE

Primary Menu

Parameter	Range	Description	Default settings	DSP settings
roFF - rHLd	roFF/rrUn/rHLd	Ramp/soak command	roFF	dSP1-1
HA	0 - 100%FS	High Alarm Setpoint	10	dSP1-2
AL*	0 - 100%FS	Low Alarm Setpoint	10	dSP1-4
Hb	0.0 - 50.0A	Heater break alarm S.P.	0.0	dSP1-8
AT	0 - 2	Auto-tuning	0	dSP1-16
LoC	0 - 2	Lock-out	0	dSP1-32

Secondary Menu

P	P	0.0 - 999.9%FS	Proportional band	5.0	dSP1-128
I	I	0 - 3200sec	Integral time	240	dSP2-1
D	D	0.0 - 999.9sec	Derivative time	60	dSP2-2
TC	TC	1 - 150sec	Cycle Time (output #1)	†	dSP2-4
HYS	HYS	0 - 50%FS	Hysteresis	1	dSP2-8
TC2	TC2	1 - 150sec	Cycle Time (output #2)	†	dSP2-16
Cool	Cool	0.0 - 100.0	Proportional band coefficient for cooling	1.0	dSP2-32
db	db	-50.0 - 50.0%FS	Deadband/Overlap	0.0	dSP2-64
bAL	bAL	0 - 100%	Balance	0.0/50.0	dSP2-128
Ar	Ar	0 - 100%FS	Anti-reset wind-up	100%FS	dSP3-1
P-n2	P-n2	0 - 16	Input type code	†	dSP3-2
P-SL	P-SL	-1999 - 9999	Lower range of input	0%FS	dSP3-4
P-SU	P-SU	-1999 - 9999	Upper range of input	100%FS	dSP3-8
P-dP	P-dP	0 - 2	Decimal point position	0	dSP3-16
P-AH	P-AH	0 - 11	Alarm Type 1 code	5	dSP3-32
P-AL*	P-AL*	0 - 15	Alarm Type 2 code	9	dSP3-64
PV0F	PV0F	-10 - 10%FS	PV offset	0	dSP3-128
SV0F	SV0F	-50 - 50%FS	SV offset	0	dSP4-1
P-F	P-F	°C/°F	°C/°F selection	†	dSP4-2
STAT	STAT	--	Ramp/soak status	oFF	dSP4-4
SV-1	SV-1	0 - 100%FS	1st S.P.	0%FS	dSP4-8
TM1r	TM1r	0 - 99hr 59min	1st ramping time	0.00	dSP4-16
TM1S	TM1S	0 - 99hr 59min	1st soaking time	0.00	dSP4-32
SV-2	SV-2	0 - 100%FS	2nd S.P.	0%FS	dSP4-64
TM2r	TM2r	0 - 99hr 59min	2nd ramping time	0.00	dSP4-128
TM2S	TM2S	0 - 99hr 59min	2nd soaking time	0.00	dSP5-1
SV-3	SV-3	0 - 100%FS	3rd S.P.	0%FS	dSP5-2
TM3r	TM3r	0 - 99hr 59min	3rd ramping time	0.00	dSP5-4
TM3S	TM3S	0 - 99hr 59min	3rd soaking time	0.00	dSP5-8
SV-4	SV-4	0 - 100%FS	4th S.P.	0%FS	dSP5-16
TM4r	TM4r	0 - 99hr 59min	4th ramping time	0.00	dSP5-32
TM4S	TM4S	0 - 99hr 59min	4th soaking time	0.00	dSP5-64
MOD	MOD	0 - 15	Ramp/soak Mode code	0	dSP5-128

Factory Preset Menu

Parameter	Range	Description	Default settings	DSP settings	
P-n1	P-n1	0 - 19	Control Action code	†	dSP6-2
P-dF	P-dF	0.0 - 900.0sec	Input Filter Constant	5.0	dSP6-4
P-An	P-An	0 - 50%FS	Alarm Hysteresis	1	dSP6-8
rCJ	rCJ	-	N/A	ON	dSP6-16
PLC1	PLC1	-	N/A	-3.0	dSP6-32
PHC1	PHC1	-	N/A	103.0	dSP6-64
PLC2	PLC2	-	N/A	-3.0	dSP6-128
PHC2	PHC2	-	N/A	103.0	dSP7-1
PCUT	PCUT	-	N/A	0	dSP7-2
FUZY	FUZY	OFF/ON	Fuzzy control	OFF	dSP7-4
GAIN	GAIN	-	N/A	1	dSP7-8
ADJ0	ADJ0	-	Zero calibration	0	dSP7-16
ADJS	ADJS	-	Span calibration	0	dSP7-32
OUT	OUT	-	N/A	-3.0	dSP7-64
dSP1	dSP1-7	0-255	Parameter mask	†	-

* Not applicable to PXV3

† Based on the model